

Photodegradation and photosensitization in pharmaceutical products: Assessing drug phototoxicity*

Gonzalo Cosa

Department of Chemistry and Biochemistry, University of Texas at Austin, Austin, TX 78712, USA

Abstract: Toxic reactants are a common result of the interaction of sunlight with pharmaceutical agents transported in the blood system or applied topically. Over the past decade there has been a considerable amount of research toward understanding both the unimolecular deactivation pathway of photoexcited pharmaceutical products and their photosensitizing capability in the presence of biological substrates. This work summarizes recent developments in the study of the photodegradation mechanism of ketoprofen, fenofibric acid, and tiaprofenic acid. An analysis of excited-state electronic energy levels, the type of intermediates formed following excitation, and transient intermediate lifetimes is presented. The analysis involves both parent drugs and their major photoproducts. Phototoxicity, usually the result of adverse photochemical reactions following direct photoexcitation of the drugs, is shown to be strongly related to the photoexcitation of photoproducts when high radiation dose conditions prevail. The photoproducts are the species directly involved in photosensitizing reactions.

INTRODUCTION

Ultraviolet light, characterized by its short wavelength (high energy), is able to pass through the different layers of the atmosphere and reach Earth. Thus, wavelengths of the UV-B (290–320 nm) and UV-A (320–400 nm) region of the spectrum, imperceptible to the human eye, are an inherent part of our everyday life [1,2]. UV-B frequencies are absorbed in the first layers of the skin, composed by the dead cells of the stratum corneum; however, wavelengths in the UV-A region are able to reach the blood irrigation system. Xenobiotic species, such as pharmaceutical products transported through the blood system, will eventually reach superficial areas in the body, where they will readily absorb the incident radiation [3]. An ample range of photophysical and photochemical reactions may possibly occur at this instance, reactions for which the organism has not evolved to protect itself. These xenobiotic-incident sunlight interactions can be very detrimental for living tissues since they can result in photoallergic and phototoxic responses. Phototoxicity will be determined by direct damage to the tissue induced by a photogenerated chemical agent [4]. Photoallergies are the response to a chemical modification of a substrate into an allergen (e.g., drug-protein adduct formation following drug photoexcitation [5]). The allergen will promote the formation of a specific antibody against its structure. Upon subsequent sun exposure, an inflammatory antibody-antigen reaction will be elicited [1,4,6].

Pure Appl. Chem.* **76, 263–319 (2004). A collection of invited, peer-reviewed articles by the winners of the 2003 IUPAC Prize for Young Chemists.

EXCITED-STATE DEACTIVATION: PHOTOCHEMISTRY VS. PHOTOPHYSICS

Following photoexcitation, the substrate will dissipate the excess energy in a chemical or physical process. Competition between photochemical and photophysical events ultimately determines to what extent a given excited state will undergo chemical reactions, or deactivate either radiatively, or by heat dissipation. The lowest excited singlet and triplet states are bottlenecks in the series of deactivation processes leading to the ground state. Photoinduced chemical reactions, with a few exceptions, will therefore occur from S_1 or T_1 as schematically illustrated in Fig. 1.

Two competing mechanisms known as type I and type II lead from excited compound to products in the presence of oxygen. The excited state (also known as sensitizer) can react directly with other substrates including the solvent via charge transfer and/or hydrogen abstraction (type I photoreaction) [7]. The sensitizer may also interact directly with oxygen, either by energy transfer to form singlet oxygen, or by electron transfer; these are commonly known as type II reactions [8].

This work summarizes recent developments in the study of the photodegradation mechanism of tiaprofenic acid (**TP**), ketoprofen (**KP**), and fenofibric acid (**FA**). The photosensitizing-phototoxic effect of these pharmaceutical products will be discussed in terms of the efficiency of generation of the excited states, their relative energy with respect to the ground state, their electronic configuration (i.e., which set of molecular orbitals is involved in the transition), how efficiently they deactivate via each pathway, and what type of intermediates are formed (as well as their reactivity) following photoexcitation. The high photosensitizing capability of **TP** relative to that of **KP**, and the low phototoxic effect of **FA** will be accounted for in terms of these parameters. Ultimately, the phototoxicity reported for these molecules is shown to result from the production of photoproducts which lack a fast deactivation mechanism, and are therefore prone to undergo type I or type II reactions within living tissues. A detailed description of the photosensitization of biological substrates is described in recent reviews [9,10].

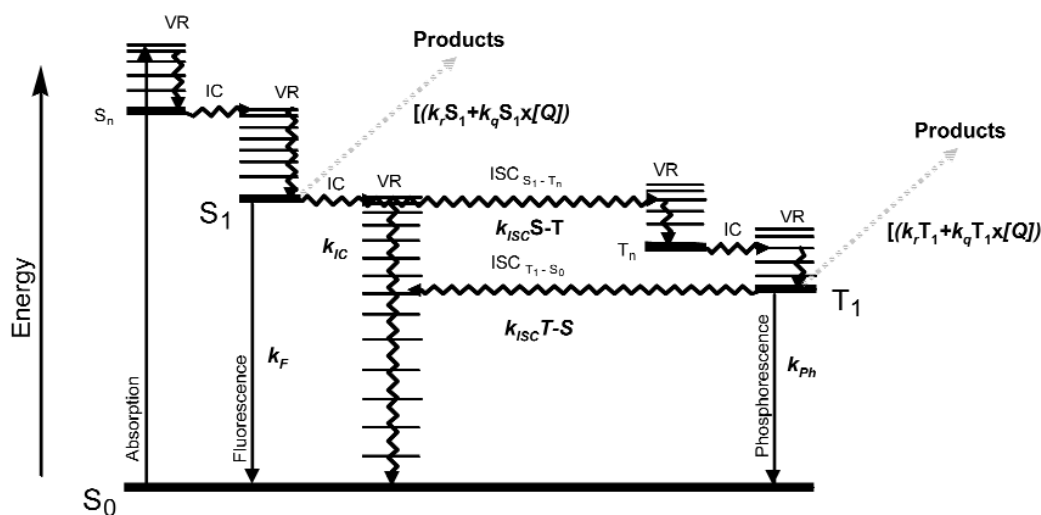

Fig. 1 Energy diagram illustrating the multiple deactivation possibilities available to the excited state. Photophysical (black arrows) and chemical (gray, dotted arrows) processes are illustrated. Rate constants for each process are also shown, thus k_r and k_q are rearrangement and quenching rate constants respectively; k_F and k_{Ph} are fluorescence and phosphorescence rate constants; and k_{IC} and k_{ISC} are the rate constants for internal conversion and intersystem crossing, respectively. The quantum yield of a chemical reaction from S_1 ($\Phi_r S_1$) will be given by the ratio of unimolecular and bimolecular reaction rate constants ($k_r S_1 + k_q S_1 \times [Q]$) over all S_1 deactivation pathways $[(k_r S_1 + k_q S_1 \times [Q]) + (k_F + k_{IC} + k_{ISC} S-T)]$. Similarly, the quantum yield of chemical reaction from T_1 ($\Phi_r T_1$) is given by the relative values of $(k_r T_1 + k_q T_1 \times [Q])$ over $[(k_{Ph} + k_{ISC} T-S) + (k_r T_1 + k_q T_1 \times [Q])]$.

GENERAL STRATEGY TO STUDY TRANSIENT INTERMEDIATES

Most of the time-resolved data currently available on drug photodegradation have been obtained with nanosecond laser flash photolysis (N-LFP). Transients generated following laser excitation with short laser pulses (ca. 5 ns) are monitored over time by registering their UV–visible absorption [11]. The transients are then assigned based on their absorption spectra, decay rate constants and reactivity toward selected substrates.

The absorption spectrum of an in situ “synthesized” homolog assists in the spectrum assignment. Two approaches are employed to generate the homolog of the suspected transient. The first relies on choosing an appropriate precursor, which, upon laser excitation and quenching by the substrate of interest, will generate the suspected transient. Triplet sensitization of the substrate is a good example of this approach [12,13]. Alternatively, the excited state of the substrate can be chemically quenched by ground-state species (such as electron acceptors) to produce the suspected transient (ca. a radical cation) in high yields [14]. Table 1 enumerates some common precursors as well as the transients that they produce following reaction with the ground-state substrate. Also shown are common quenchers of excited substrates. In the case of energy transfer systems, the precursor is referred to as a sensitizer.

Table 1 Precursors most commonly employed in the study of pharmaceutical products, as well as the products of their reaction.^a

Chromophore	Ground-state quencher	Reaction	Product observed	Ref.
SO ₄ ⁻	Substrate	Electron transfer	1 e ⁻ oxidized	[14–17]
chloranil triplet				[18]
Substrate	Chloranil MeV ²⁺	Electron transfer	1 e ⁻ oxidized	[14] [19]
Substrate	Triethylamine, aniline	Electron transfer	1 e ⁻ reduced	[19,20]
<i>tert</i> -Butoxyl radical	Substrate	Hydrogen abstraction	Radicals	[21–23]
Triplet sensitizers	Substrate	Energy transfer	Triplet state	[12,24–26]

^a“Substrate” can be a ground or excited state.

Decay rate constants are assigned from quenching experiments. It is common to add a quencher that will introduce a new mechanism for the deactivation of the transient (*T*) produced following excitation of the ground state (*GS*). Energy acceptors, radical traps, hydrogen donors, O₂, electron donors or acceptors, etc. (see Tables 1 and 2), are the most common. We observe how (if any) the experimental rate constant (*k*_{exp}) increases in the presence of these quenchers [*Q*]. The situation is exemplified in Scheme 1.

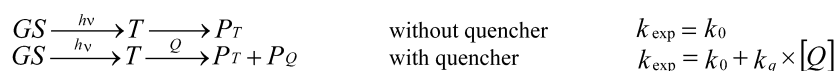

Scheme 1 Change in the decay rate constant with the addition of a quencher.

The linear dependence of *k*_{exp} with quencher concentration yields the value of *k*₀ and *k*_q from the intercept and the slope, respectively, of a plot of the observed rate constant *k*_{exp} vs. the quencher concentration [*Q*]. The nature and reactivity of the observed transient is determined from a comparison of the experimental *k*₀ and *k*_q with literature values.

The choice of a given quencher aims to rule out or to confirm the identity of a given type of transient. Many different types of quenchers can be used, Table 2 lists only those most commonly employed in the study of drug photostability.

Table 2 Most commonly encountered transients and quenchers employed.

Transient	Quencher	Ref.
Solvated electron	2-chloroethanol	[27]
	O ₂	[28]
	N ₂ O	[29]
Triplet state (E _T ≥ 240 kJ/mol)	Naphthalene, 1-naphthalenemethanol	[30,31]
	1,3-cyclohexadiene	[14,32]
	sorbic acid	[15,33]
Triplet state (E _T < 240 kJ/mol)	β-carotene	[24]
	O ₂	[25]
	4-OH-TEMPO	[34]
^a Carbon centered radical	O ₂	[35]
	TEMPO	[36,37]
Carbanion	O ₂	[32,33]
	Cu ²⁺	[34,38]
	MeV ²⁺	[34]
Radical anion	Electrophile	[39]
Carbocation	Sodium azide, H ₂ O	[17,40]
	Cl ⁻ , ethanol	[41]
Radical cation	Cysteine, sodium azide, HO ⁻ ,	[14,16]
	<i>N,N,N',N'</i> -tetramethyl- <i>p</i> -phenylendiamine,	[15,42]
	MeOH, Br ⁻ , CH ₃ CO ₂ ⁻ , Cl ⁻	[18]
^b Singlet oxygen	Sodium azide, DABCO, β-carotene	[43]
Carbene	Cl ⁻ , nucleofiles	[44–46]

^aOther type of radicals are described by Fossey et al. [47].

^bThese quenchers react with singlet oxygen without net chemical change [43].

PHOTOCHEMISTRY OF KETOPROFEN, FENOFIBRIC ACID, AND TIAPROFENIC ACID

In the following section, the photochemistry and photophysics of these three pharmaceutical products are briefly summarized.

Photochemistry of ketoprofen (KP)

The drug **KP** is a rather simple substituted benzophenone (**BP**) commercialized as a nonsteroidal anti-inflammatory drug (NSAID). It has been involved in adverse photosensitization reactions [48,49]. A number of studies have been performed to understand the photobiological effects of **KP**. Thus, there exist reports in the literature where photohemolysis [49–51], lipid peroxidation [52], DNA damage [53,54], and other assays [55], provide evidence of its phototoxicity.

Ketoprofen is characterized by unusual pH-dependent photochemistry [32,33,52,56–58]. The anionic form of **KP** rapidly (within 1 ns or faster [59]) undergoes decarboxylation from the singlet excited state in aqueous buffer at pH 7.4. This decarboxylation yields a carbanion [32,33]. This is a highly efficient process with a quantum yield $\Phi_{\text{dec}} \sim 0.75$ [49]. The photogenerated carbanion undergoes protonation within 200 ns to yield ethyl benzophenone (see Scheme 2). The mechanism of decarboxylation of **KP** is heterolytic in nature [60] as inferred from results obtained with **KP** [32,33] and with various analogs of **KP** [61].

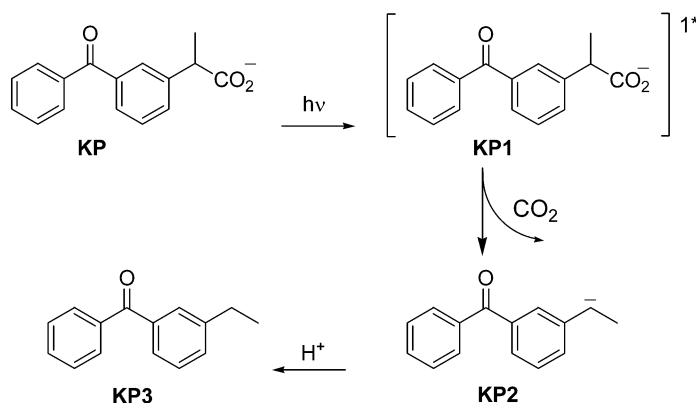

Scheme 2 Photodegradation mechanism of **KP** [32,33].

Photochemistry of fenofibric acid (FA)

Fenofibric acid is a hypolipidemic drug circulating in the blood stream. It is a metabolite of the commercially available prodrug fenofibrate [62,63]. **FA** has the structure of benzophenone. Its ground-state absorption extends over the UV-A part of the solar spectrum. The combined effects of UV-A and **FA** can result in photosensitized DNA damage [53], peroxidation of fatty acids [64], and red blood cell hemolysis [10]. However, its phototoxic effect is reportedly lower than that of **KP** [53].

Following excitation of the carboxylate form of **FA** in aqueous buffer at pH 7.4, it undergoes intersystem crossing (ISC) to the lowest triplet excited state (**FA1** in Scheme 3). The quantum yield of singlet–triplet intersystem crossing is low ($\Phi_{ISC} \sim 0.3$) as determined for the model compound 4-methoxybenzophenone [13]. The lowest triplet state of π, π^* nature is in equilibrium with a higher-energy triplet state of n, π^* nature (**FA2**). Decarboxylation occurs from this higher-energy triplet state with $\Phi_{dec} \sim 0.06$ resulting in the depletion of the triplet state with a lifetime (τ) of ~ 600 ns [31]. A transient intermediate of biradical nature (**FA3**) is formed upon decarboxylation. This intermediate undergoes ISC and protonation with a lifetime ~ 600 ns to yield two products, 4-chloro-4'-(1-hydroxy-1-methylethyl)benzophenone (**FA4**) and 4-chloro-4'-(1-isopropoxy)benzophenone (**FA5**) [30,31].

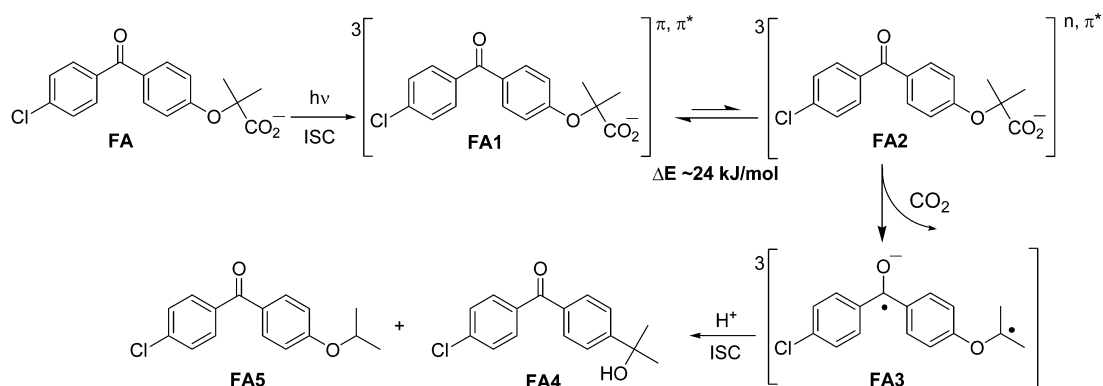

Scheme 3 Photodegradation mechanism of **FA** [30,31].

Photochemistry of tiaprofenic acid (TP)

Tiaprofenic acid (**TP**) {2-[4-(2-benzoyl)thiophenyl]propionic acid} is the most phototoxic nonsteroidal anti-inflammatory agent. It mainly acts by photosensitization [65]. **TP** is known to elicit photocontact

dermatitis [66]. Its phototoxicity has been clinically reported and confirmed by in vivo and in vitro laboratory tests [3]. **TP** induces lipid peroxidation. When DNA is irradiated with low concentrations of **TP**, photooxidative damage occurs [9].

The photodegradation mechanism of **TP** is illustrated in Scheme 4. The lowest triplet state of **TP** (**TP1** in Scheme 4) is generated with an efficiency Φ_{ISC} of ~ 0.9 . The lowest triplet state of π, π^* nature is in equilibrium with a higher-energy triplet state of n, π^* nature (**TP2**). Decarboxylation occurs from this higher-energy triplet state with $\Phi_{dec} \sim 0.25$ resulting in depletion of the triplet state within ~ 800 ns [67]. A triplet biradical is formed which upon intersystem crossing (with a lifetime of 1.5 μ s) and protonation forms the photodecarboxylated product **TP4** [67].

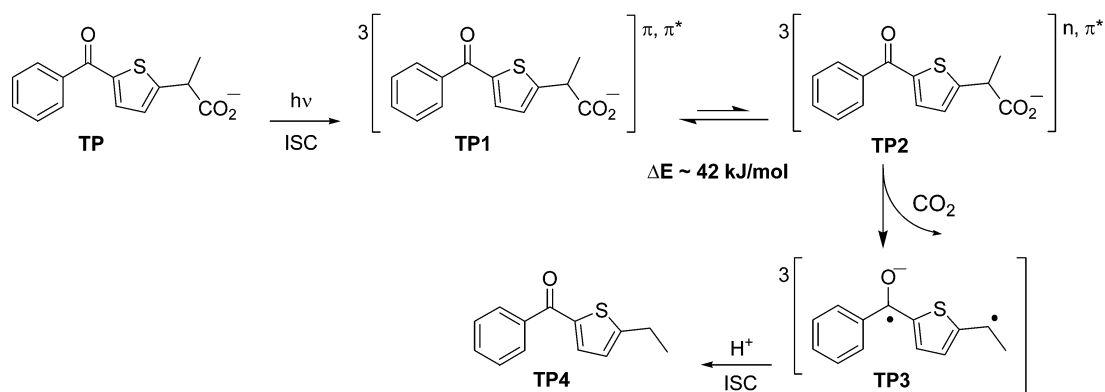

Scheme 4 Photodegradation mechanism of **TP** [67].

PRECURSORS VS. PHOTOPRODUCTS

The higher phototoxicity of **TP** compared to **KP** [33], which is in turn higher than that of **FA**, cannot be directly understood on the sole basis of the photochemistry of these compounds. The photochemistry and photophysics of their photoproducts should also be analyzed in order to understand the phototoxicity of these three drugs. Table 3 illustrates the main electronic configuration characteristics for the

Table 3 Electronic configuration, quantum yields, and deactivation rate constants for the drugs and their photoproducts.

	$\Phi_r S_1$	τS_1 (ns) ^a	Φ_{ISC} S-T	T_1 config.	$\Phi_r T_1$	τT_1 (ns) ^b	Φ_{Δ}^1	$\tau_{interm.}$ (ns)	Ref.
BP	0	≤ 1	1	n, π^*	–	25 000	< 0.01 [9]	–	[68]
KP⁻	0.75	≤ 1	0	–	–	–	0 [9]	200	[32,33]
KP3	0	≤ 1	1	n, π^*	–	3000	–	–	[32,33]
FA⁻	0	≤ 1	≤ 0.3	π, π^*	0.06	600	–	≤ 600	[30,31]
FA4	0	≤ 1	1	n, π^*	–	3100	–	–	[28]
FA5	0	≤ 1	≤ 0.3	π, π^*	–	3100	–	–	[28]
TP⁻	0	≤ 1	0.9	π, π^*	0.25	800	0.22 [56]	1500	[67]
TP4	0	≤ 1	0.9	π, π^*	–	3200	–	–	[67]

^aThese values are a maximum estimate from N-LFP experiments. The singlet excited state of benzophenone has a lifetime of ~ 15 ps in acetonitrile, no major changes are expected in water [69]. In the case of **FA** and **TP**, slower ISC to triplet states are expected based on El Sayed's rules [25] (the lowest singlet excited state are n, π^* [9,70], the second highest triplet level is n, π^* and the lowest triplets are π, π^* [31,67,70]).

^bThese values could be underestimated as a result of inefficient removal of oxygen from the systems. This would explain the higher value measured for benzophenone.

drugs in their anionic form. It also illustrates the deactivation rate constants for the drugs and for the intermediates produced following laser excitation. Table 3 also lists the main electronic configuration characteristics and deactivation rate constants of the photoproducts. All the photoproducts preserve intact the chromophore structure of the parent drug, with the exception of compound **FA4**. These photoproducts have the same molar absorption coefficient, triplet-state configuration and singlet-state lifetime as their parent compounds. The characteristic photodecarboxylation pathway is nonoperant at low pH values or when the ester form of the compound is employed in all three drugs. The photophysics and photochemistry of the photoproducts are indistinguishable from those of the ester form of the compound or its protonated form [9,10,31,33].

Molar absorption coefficient

All three drugs strongly absorb in the UV-C and UV-B regions. Only **FA** and **TP** have strong absorptions in the UV-A region. Peak molar absorption coefficient values of $14\,000\text{ M}^{-1}\text{ cm}^{-1}$ for **TP** at 314 nm [9], $20\,000\text{ M}^{-1}\text{ cm}^{-1}$ for **FA** at 298 nm, and $16\,000\text{ M}^{-1}\text{ cm}^{-1}$ for **KP** at 254 nm [28] position **TP** and its photoproducts as the most potentially phototoxic compounds.

Charge

The negative charge on **KP**, **FA**, and **TP** is a key difference with respect to the neutral photoproducts. Coulombic repulsion will prevent the drug association with DNA (increased association to DNA has been described for cationic adducts of benzophenone [71]). The photoproducts on the contrary will preferentially partition in hydrophobic environments such as DNA base pair pockets, where electron transfer from guanine bases or hydrogen abstraction from the sugar bases could readily occur. Preferential partition of the photoproducts in lipid membranes will also result in a higher photosensitization of critical cellular material in comparison to the corresponding drugs [72]. Drug photoproducts are potentially more toxic given their preferential partition in biological sensitive material.

Excited-state lifetime

The drugs **KP**, **FA**, and **TP**, undergo photochemical degradation in aqueous pH ~7 solutions where they exist in the anionic form. The excited-state lifetime is considerably reduced as a result of this deactivation mechanism (see Fig. 1 and values in Table 3). The probability that the pharmaceutical product will undergo a photosensitization reaction is directly proportional to its lifetime. It is expected that in all three cases the photosensitizing activity for the parent drug is much lower than for the photoproduct. This is *analogous to the molecular mechanism of sunscreens, which dissipate the absorbed energy in a fast efficient manner*. Contrary to sunscreens however, the deactivation leads to reactive intermediates for these compounds. An analysis of Table 3 reveals that in all cases the biradical like intermediates are short-lived. In fact, their lifetime is shorter than that of the triplet excited states of the photoproducts.

Figure 2 illustrates the predictions for the mean displacement of the photoexcited compounds within their excited-state lifetimes.

These predictions are done applying the diffusion theory for a low-viscosity solvent like water [73]. The predictions indicate that in the singlet excited state the compounds will remain within 1 nm of the excitation point. All other photogenerated intermediates will, however, explore distances that on average are 1 % of a cell diameter. This can result in the photosensitization of biological sensitive material, like DNA, or unsaturated lipids within the cell membranes. The longer-lived a transient is, the higher the possibilities for a sensitization to occur. It is safe to conclude at this point that photoproducts are more phototoxic than the parent drugs on the basis of their charge and excited-state lifetime, assuming similar photosensitizing properties for both the drugs and the photoproducts, and not considering the phototoxic effect of the intermediates formed.

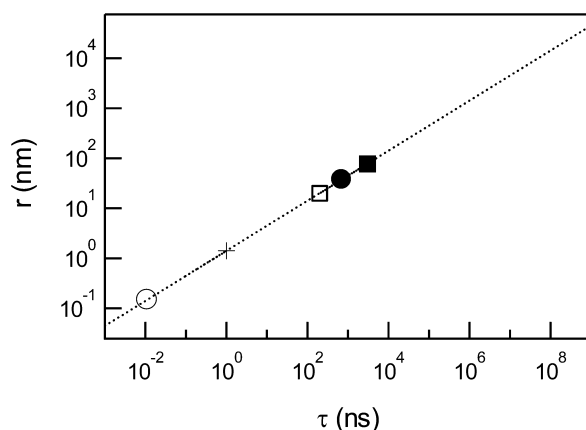
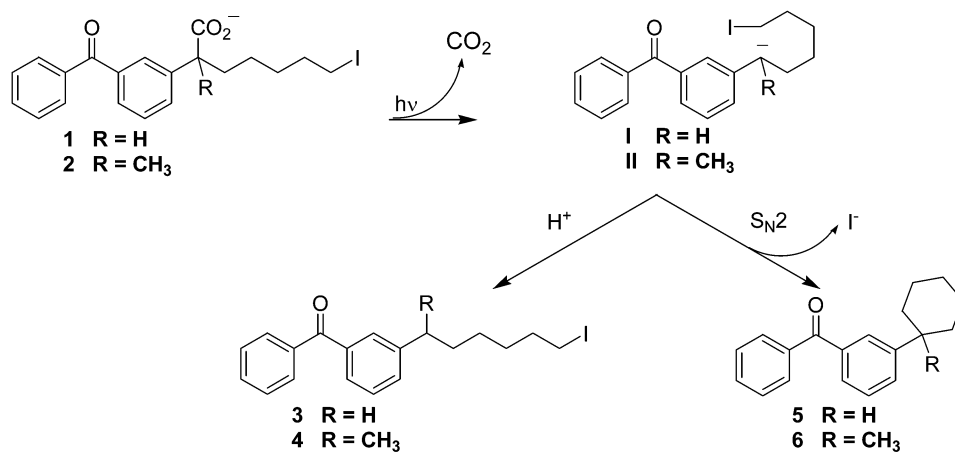

Fig. 2 Relationship between mean distance traveled (r) and time for small molecules in a low-viscosity solvent like water [73]. $r = (2 \times D \times t)^{(1/2)}$ where D is the diffusion coefficient. Note that D is ~ 3 orders of magnitude smaller in a phospholipid bilayer than in water [74]. (○) Mean distance traveled by benzophenone while in the singlet excited state. (+) Mean distance (a maximum estimate) traveled by the pharmaceutical products while in the singlet excited state. (□) Mean distance traveled by the **KP** carbanion before protonation. (●) Mean distance traveled by the biradical intermediates before ISC. (■) Mean distance traveled by the photoproducts while in the triplet excited state.

Transient intermediates

The biradical intermediates **TP3** and **FA3** may undergo photosensitizing reactions. The fast decay of **KP** carbanion and its singlet multiplicity makes it unlikely for reactions other than protonation to occur. To gain insight into the reactivity of these carbanions, comparative studies of the photodecarboxylation of compounds **1** and **2** were performed in 0.1 M KOH aqueous solution and in dimethylsulfoxide (DMSO) [75]. Compounds **1** and **2** contain an electrophilic carbon center. Upon photoexcitation, and subsequent decarboxylation, they yield carbanions **I** and **II**, respectively. These carbanions could either react with water or undergo an intramolecular S_N2 reaction (see Scheme 5).

Photolysis of **1** and **2** in a 0.1 M KOH aqueous solutions afforded predominantly the protonated compounds **3** (yield 0.93) and **4** (0.97), respectively (see Scheme 5). The cyclic compounds **5** (0.07) and **6** (0.03) were obtained in low yields. Extreme anhydrous conditions had to be employed in order to ob-



Scheme 5 Reaction scheme for 1-(3-benzoyl-phenyl)-alkyl carbanions [75].

serve **KP** and **KP** derivatives carbanion chemistry other than protonation. Thus, quantitative cyclizations of compounds **1** and **2** were only observed in rigorously dried DMSO, to which an excess of NaH was added to generate the corresponding carboxylate forms [75]. Water traces yielded the protonated carbanion as the major product, where water is ca. 400 fold more reactive in DMSO than in aqueous media.

Experiments in zeolite cavities yielded the reaction of **KP** carbanion with acetaldehyde. **KP** anion was included in zeolite NaY, a faujasite with cages of approximately 13 Å in diameter. The anhydrous conditions within the zeolite framework increased the lifetime of the photogenerated carbanion more than ten-fold [76].

It is safe to conclude from these experiments that photogenerated **KP** intermediates have an extremely low potential for adverse reactions within an aqueous environment even in the highly hydrophobic media of the cellular membrane or the cell nucleus.

A survey of Table 3 illustrates that **KP** is the least phototoxic compound. It promptly deactivates to a carbanion that rapidly protonates [32,33,75,77]. **FA** has an extremely low yield of triplet formation in water, which in turn results in a low yield of biradical (**FA3**) production. **FA** is expected to be more phototoxic than **KP**. **TP** is the most phototoxic agent given its high efficiency of triplet formation and degradation into a long-lived biradical (**TP3**).

Triplet-state energy and configuration

The triplet-state configuration of each compound and that of its photoproduct is critical in establishing a sensitizing pattern. The lowest-lying triplet state is of π,π^* nature in all cases, but not in **FA4** and **KP** photoproducts. The lowest triplet states in **FA4** and **KP** are n,π^* , like in benzophenone. The n,π^* configuration yields a very electrophilic carbonyl oxygen with an alkoxy radical character. Hydrogen abstraction from unsaturated lipids and DNA sugar backbone will be a main reaction for these type of substrates [9,10]. The n,π^* triplets of benzoylketones such as benzophenone have energies of ~286 kJ/mol [78]. This value is considerably higher than that of the π,π^* lowest triplet level in **FA** (~274 kJ/mol [31]) and in **TP** (~240 kJ/mol [79]). Thermal equilibration with the higher-energy n,π^* triplet accounts for the activation barriers measured in the photodecarboxylation of **TP** and **FA** (see Schemes 2 and 3). It also accounts for the hydrogen abstraction activation barriers measured for their photoproducts [13,28,31,67,79]. The lowest π,π^* triplet state acts as a “triplet trap” and reduces the yield of decarboxylation and sensitization of **FA**, **TP**, and their derivatives.

Energy and electron transfer may occur between an excited triplet state and purine and pyrimidine bases in the DNA backbone. Whereas free bases will only be sensitized with compounds having triplet energies higher than ~306 kJ/mol, bases within the DNA backbone can be readily sensitized by benzophenone, as determined from cyclobutane pyrimidine dimer yields [12]. Triplet sensitization depends directly on the energy of the donor. It is foreseeable that the lowest triplets of π,π^* nature will not significantly sensitize DNA bases. In the case of electron transfer, and due to their electrophilic nature excited ketones are good oxidants. As a result of their low standard potential purine bases, in particular guanine, will undergo oxidation via a type I mechanism [12,54]. The n,π^* triplet states, having higher energy than π,π^* triplets, are expected to have a higher photoreduction yield as derived from Rehm–Weller equation [80]. On the basis of triplet-state energy and configuration **KP** photoproduct is considerably more phototoxic than photoproducts from **TP** or **FA** in aqueous solutions. An inversion to an n,π^* lowest triplet has been measured for **FA5** and the ethyl ester of fenonfibric acid in low polarity solvents. It is foreseeable that the photoproducts of **FA**, once formed, will preferentially partition in hydrophobic environments [72], where they will exhibit as high a phototoxicity as that of **KP** photoproducts.

Interaction with molecular oxygen

The previous discussion rationalizes the phototoxicity of the drugs and their photoproducts within a type I reaction mechanism. A type II mechanism involves the generation of singlet oxygen [$O_2(^1\Delta_g)$] and superoxide radical anion following the interaction of a photoexcited substrate with molecular oxygen [7,8]. The reported value for $O_2(^1\Delta_g)$ sensitization from triplet **TP** (Φ_{Δ}^1) is 0.22 in D_2O , pD 7.6. In a KOH basified mixture of acetonitrile/ethanol (4/1) $\Phi_{\Delta}^1 = 0.20$ for **TP** and $\Phi_{\Delta}^1 = 0.58$ for **TP4** [56]. A $\Phi_{\Delta}^1 \sim 0.01$ has been reported for **BP** in D_2O , pD 7.2; a similar value is expected for **FA4** [9]. No values are reported for **FA** or **FA5**. A safe estimate is a quantum yield <0.3 for singlet oxygen sensitization for **FA5** given the low yield of ISC in water. An even smaller value is expected for **FA** based on the fast deactivation of the excited triplet state. Oxygen involvement in the deactivation of **KP** carbanion and **FA** and **TP** triplet states does not play a major role because of the fast decays characterizing these intermediates. A similar situation is encountered with many other arylpropionic acid drugs [56]. Photoproducts are better sensitizers of $O_2(^1\Delta_g)$. **TP4** is expected to be the most phototoxic compound given the high values of Φ_{Δ}^1 measured.

CONCLUSIONS

The characteristic molar absorption coefficient, excited-state lifetimes, singlet oxygen sensitization and photogenerated intermediates position the phototoxicity of the drugs in the order **KP** < **FA** < **TP**. The excited drugs in their anionic form undergo fast deactivation in water with different yields of photodegradation. The photogenerated intermediates rapidly undergo protonation. *In all cases, photoproducts are more phototoxic than the parent drugs on the basis of their longer excited-state deactivation lifetimes and their higher solubility in hydrophobic environments. Drugs that generate photoproducts in higher yields are thus expected to be (potentially, i.e., under high radiation doses) more phototoxic.* The expected phototoxicity order then follows **KP** > **TP** > **FA**.

The photoproducts preserve intact their precursor drug chromophore structure. Upon excitation they will give rise to long-lived triplet states of comparable lifetimes ca. .3 μs . On the basis of interaction with molecular oxygen, **TP4** is predicted to be the most phototoxic photoproduct as a result of its high yield of singlet oxygen sensitization. A similar order is expected based on the molar absorptivities of photoproducts. Considerations of triplet-state energy and configuration position **KP4** as the most phototoxic photoproduct, followed by **FA4** and **TP4**.

The summary presented herein illustrates that phototoxicity values critically depend on the experimental conditions employed. In vitro studies should accurately reproduce the solar radiation spectrum, as well as the free oxygen concentration found in living systems. It is also extremely important to undertake the biological photosensitization studies under low radiation doses, and to correlate them with the drug photodegradation. Recent results illustrate how **KP** indeed *protects* blood mononuclear cells from photoinduced DNA damage under low radiation conditions. An opposite effect is observed with **TP**. Upon high irradiation doses, both drugs show similar levels of phototoxicity [81].

ACKNOWLEDGMENTS

The author is thankful to the University of Ottawa and the Ontario Graduate Scholarship Program for financial support in the form of graduate scholarships. The author is also grateful to Prof. J. C. (Tito) Scaiano at the University of Ottawa for his guidance.

REFERENCES

1. G. Porter. In *Light, Chemical Change and Life: A Source Book in Photochemistry*, J. D. Coyle, R. R. Hill, D. R. Roberts (Eds.), pp. 2–9, Open University Press, Milton Keynes (1982).

2. R. Robberecht. In *The Science of Photobiology* 2nd ed., K. C. Smith (Ed.), pp. 135–144, Plenum Press, New York (1989).
3. G. Condorelli, L. L. Constanzo, G. De Guidi, S. Giuffrida, P. Miano, S. Sortino, A. Velardita. *EPA Newsletter* **58**, 60–77 (1996).
4. M. A. Miranda. In *In Vitro Methods in Pharmaceutical Research*, pp. 290–315, Academic Press, London (1997).
5. M. A. Miranda, J. V. Castell, D. Hernandez, M. J. Gomez-Lechon, F. Boscá, I. M. Morera, Z. Sarabia. *Chem. Res. Toxicol.* **11**, 172–177 (1998).
6. J. H. Epstein. In *The Science of Photobiology* 2nd ed., K. C. Smith (Ed.), pp. 155–192, Plenum Press, New York (1989).
7. M. J. Peak and J. G. Peak. In *CRC Handbook of Organic Photochemistry and Photobiology*, W. M. Horspool and P.-S. Song (Eds.), pp. 1318–1325, CRC Press, Boca Raton, FL (1995).
8. C. Foote. *Photochem. Photobiol.* **54**, 659 (1987).
9. F. Boscá, M. L. Marín, M. A. Miranda. *Photochem. Photobiol.* **74**, 637–655 (2001).
10. F. Boscá and M. A. Miranda. *J. Photochem. Photobiol. B: Biol.* **43**, 1–26 (1998).
11. L. M. Hadel. In *Handbook of Organic Photochemistry*, Vol. II, J. C. Scaiano (Ed.), pp. 279–292, CRC Press, Boca Raton, FL (1989).
12. I. G. Gut, P. D. Wood, R. W. Redmond. *J. Am. Chem. Soc.* **118**, 2366–2377 (1996).
13. F. Boscá, G. Cosa, M. A. Miranda, J. C. Scaiano. *Photochem. Photobiol. Sci.* **1**, 704–708 (2002).
14. L. J. Martínez and J. C. Scaiano. *Photochem. Photobiol.* **68**, 646–651 (1998).
15. S. Sortino and J. C. Scaiano. *Photochem. Photobiol.* **70**, 590–595 (1999).
16. S. C. Steenken, J. Warren, B. C. Gilbert. *J. Chem. Soc., Perkin Trans. 2* 335–342 (1990).
17. R. A. McClelland, N. Mathivanan, S. Steenken. *J. Am. Chem. Soc.* **112**, 4857–4861 (1990).
18. C. S. Q. Lew, J. R. Brisson, L. J. Johnston. *J. Org. Chem.* **62**, 4047–4056 (1997).
19. P. K. Das. *Tetrahedron Lett.* **22**, 1307–1310 (1981).
20. K. Bhattacharyya and P. K. Das. *J. Phys. Chem.* **90**, 3987–3993 (1986).
21. P. K. Das, M. V. Encinas, S. Steenken, J. C. Scaiano. *J. Am. Chem. Soc.* **103**, 4162–4166 (1981).
22. C. Evans, J. C. Scaiano, K. U. Ingold. *J. Am. Chem. Soc.* **114**, 4589–4593 (1992).
23. S. Sortino, J. C. Scaiano, G. Condorelli. *J. Phys. Chem. B* **103**, 9279–9284 (1999).
24. I. Carmichael and G. L. Hug. In *Handbook of Organic Photochemistry*, Vol. I, J. C. Scaiano (Ed.), pp. 369–403, CRC Press, Boca Raton, FL (1989).
25. A. Gilbert and J. Baggott. *Essentials of Molecular Photochemistry*, Blackwell Scientific, Oxford (1991).
26. P. D. Wood and R. W. Redmond. *J. Am. Chem. Soc.* **118**, 4256–4263 (1996).
27. S. Sortino, J. C. Scaiano, G. De Guidi, S. Monti. *Photochem. Photobiol.* **70**, 549–556 (1999).
28. G. Cosa. (2002). Study on the mechanism of photodegradation of pharmaceutical products and analogues and development of a novel fluorescence technique for DNA-damage detection. Ph.D. Thesis, Univ. of Ottawa, Ottawa.
29. G. V. Buxton, C. L. Greenstock, W. P. Helman, A. B. Ross. *J. Phys. Chem. Ref. Data* **17**, 516–886 (1988).
30. F. Boscá and M. A. Miranda. *Photochem. Photobiol.* **70**, 853–857 (1999).
31. G. Cosa, S. Purohit, J. C. Scaiano, F. Boscá, M. A. Miranda. *Photochem. Photobiol.* **75**, 193–200 (2002).
32. G. Cosa, L. J. Martínez, J. C. Scaiano. *PCCP* **1**, 3533–3537 (1999).
33. L. J. Martínez and J. C. Scaiano. *J. Am. Chem. Soc.* **119**, 11066–11070 (1997).
34. S. Sortino and J. C. Scaiano. *Photochem. Photobiol.* **69**, 167–172 (1999).
35. B. Maillard, K. U. Ingold, J. C. Scaiano. *J. Am. Chem. Soc.* **105**, 5095–5099 (1983).
36. J. Luszyk and J. M. Kanabus-Kaminska. In *Handbook of Organic Photochemistry*, Vol. II, J. C. Scaiano (Ed.), pp. 369–403, CRC Press, Boca Raton, FL (1989).

37. J. Chateaufneuf, J. Lusztyk, K. U. Ingold. *J. Org. Chem.* **53**, 1629–1632 (1988).
38. S. Sortino, J. C. Scaiano, G. De Guidi, L. L. Costanzo. *Chem. Commun.* 2003–2004 (1999).
39. A. Albini, E. Fasani, M. Mella. *Top. Curr. Chem.* **168**, 143–173 (1993).
40. R. A. McClelland, V. M. Kanagasabapathy, S. Steenken. *J. Am. Chem. Soc.* **110**, 6913–6914 (1988).
41. M. L. Barcellona, G. Cardiel, E. Gratton. *Biochem. Biophys. Res. Commun.* **170**, 270–280 (1990).
42. S. Fujita and S. Steenken. *J. Am. Chem. Soc.* **103**, 2540–2545 (1981).
43. C. Foote. In *Light Activated Pesticides*, Vol. Ser. 339, K. R. Downum (Ed.), pp. 22–38, American Chemical Society, Washington, DC (1987).
44. L. J. Martínez, G. Li, C. F. Chignell. *Photochem. Photobiol.* **68**, 20–24 (1998).
45. E. Fasani, M. Mella, D. Caccia, S. Tassi, M. Fagnoni, A. Albini. *Chem. Commun.* 1329–1330 (1997).
46. E. Fasani, F. F. Barberis negra, M. Mella, S. Monti, A. Albini. *J. Org. Chem.* **64**, 5388–5395 (1999).
47. J. Fossey, D. Lefort, J. Sorba. *Free Radicals in Organic Chemistry*, Trans. J. Lomas, Wiley, Paris (1995).
48. A. Alomar. *Contact Dermatitis* **12**, 112–113 (1985).
49. L. L. Costanzo, G. De Guidi, G. Condorelli, A. Cambria, M. Fama. *Photochem. Photobiol.* **50**, 359–365 (1989).
50. C. F. Chignell and R. H. Sik. *Photochem. Photobiol.* **67**, 591–595 (1998).
51. C. F. Chignell and R. H. Sik. *Photochem. Photobiol.* **62**, 205–207 (1995).
52. F. Boscá, M. A. Miranda, G. Carganico, D. Mauleón. *Photochem. Photobiol.* **60**, 96–101 (1994).
53. M. C. Maguery, N. Chouini-Lalanne, J. C. Ader, N. Paillous. *Photochem. Photobiol.* **68**, 679–684 (1998).
54. V. Lhiaubet, N. Paillous, N. Chouini-Lalanne. *Photochem. Photobiol.* **74**, 670–678 (2001).
55. F. Boscá, M. A. Miranda, G. Carganico, D. Mauleón. *J. Photochem. Photobiol. B: Biol.* **31**, 133–138 (1995).
56. D. de la Peña, C. Martí, S. Nonell, L. A. Martínez, M. A. Miranda. *Photochem. Photobiol.* **65**, 828–832 (1997).
57. S. Monti, S. Sortino, G. De Guidi, G. Marconi. *J. Chem. Soc., Faraday Trans.* **93**, 2269–2275 (1997).
58. S. Monti, S. Sortino, G. De Guidi, G. Marconi. *New J. Chem.* **22**, 599–604 (1998).
59. C. D. Borsarelli, S. E. Braslavsky, S. Sortino, G. Marconi, S. Monti. *Photochem. Photobiol.* **72**, 163–171 (2000).
60. D. Budac and P. Wan. *J. Photochem. Photobiol. A: Chem.* **67**, 135–166 (1992).
61. M. Xu and P. Wan. *Chem. Commun.* 2147–2148 (2000).
62. H. U. Kloer. *Am. J. Med.* **83**, 3–8 (1987).
63. L. F. Elsom, D. R. Hawkins, L. F. Chasseaud. *J. Chromatogr.* **123**, 463–467 (1976).
64. M. A. Miranda, F. Boscá, F. Vargas, N. Canudas. *Photochem. Photobiol.* **59**, 171–174 (1994).
65. E. Holzle, N. Neumann, B. Hausen, B. Przybilla, S. Schauder, H. Honigsmann, A. Bircher, G. Plewig. *J. Am. Acad. Dermatol.* **25**, 59–68 (1991).
66. R. A. Neumann, R. M. Knobler, H. Lindemayr. *Contact Dermatitis* **20**, 270–273 (1989).
67. S. Encinas, M. A. Miranda, G. Marconi, S. Monti. *Photochem. Photobiol.* **68**, 633–639 (1998).
68. R. V. Bensasson and J.-C. Gramain. *J. Chem. Soc. Faraday I* **76**, 1801–1810 (1980).
69. P. F. McGarry, C. E. J. Doubleday, C.-H. Wu, H. A. Staabb, N. J. Turro. *J. Photochem. Photobiol. A: Chem.* **77**, 109–117 (1994).
70. R. S. Becker, G. Favaro, G. Poggi, A. Romani. *J. Phys. Chem.* **99**, 1410–1417 (1995).
71. N. Mohtat, F. L. Cozens, T. Hancock-Chen, J. C. Scaiano, J. McLean, J. Kim. *Photochem. Photobiol.* **67**, 111–118 (1998).

72. L. R. C. Barclay, K. A. Baskin, S. J. Locke, T. D. Schaefer. *Can. J. Chem.* **65**, 2529–2549 (1987).
73. N. J. Turro, J. C. Scaiano, V. Ramamurthy. *Modern Molecular Photochemistry of Organic Molecules*, University Science Books, Sausalito. In press.
74. M. J. Saxton and K. Jacobson. *Annu. Rev. Biophys. Biomol. Struct.* **26**, 373–399 (1997).
75. L. Llauger, G. Cosa, J. C. Scaiano. *J. Am. Chem. Soc.* **124**, 15308–15312 (2002).
76. M. N. Chrétien, G. Cosa, H. García, J. C. Scaiano. *Chem. Commun.* 2154–2155 (2002).
77. G. Cosa, L. Llauger, J. C. Scaiano, M. A. Miranda. *Org. Lett.* **4**, 3083–3085 (2002).
78. N. J. Turro. *Modern Molecular Photochemistry*, University Science Books, Sausalito (1991).
79. S. Encinas, M. A. Miranda, G. Marconi, S. Monti. *Photochem. Photobiol.* **67**, 420–425 (1998).
80. D. Rehm and A. Weller. *Isr. J. Chem.* **8**, 259–271 (1970).
81. A. L. Vinette, J. P. McNamee, P. V. Bellier, J. R. N. McLean, J. C. Scaiano. *Photochem. Photobiol.* **77**, 390–396 (2003).