

Synthetic studies on the marine natural product halichondrins*

Hyeong-wook Choi, Damtew Demeke, Fu-An Kang, Yoshito Kishi[‡],
Katsumasa Nakajima, Pawel Nowak, Zhao-Kui Wan, and Chaoyu Xie

Department of Chemistry and Chemical Biology, Harvard University, 12 Oxford
Street, Cambridge, MA 02138, USA

Abstract: In connection with the development of a practical synthesis of the right half, and its analog E7389, of halichondrin B, an efficient and scalable synthesis of the two major building blocks is reported. In addition, a new synthesis of the C20–C26 segment via a regioselective and stereoselective S_N2' process is presented. A sulfonamide class of ligands is shown to be effective for asymmetric Ni/Cr-mediated reactions under both stoichiometric and catalytic conditions, and the X-ray structure reveals this class of ligands to be tridentate. On the basis of three X-ray structures, a possible mechanism is suggested for this process. Stable and crystalline Cr(III)/sulfonamide complexes are shown to be effective for catalytic Cr-mediated coupling reactions of allyl, alkenyl, and alkyl halides with aldehydes, and some examples for application of the stoichiometric and catalytic asymmetric processes are presented.

INTRODUCTION

Halichondrins are the polyether macrolides, originally isolated from the marine sponge *Halichondria okadai* by Hirata and Uemura, which have received much attention due to their intriguing structural architecture and extraordinary in vitro and in vivo antitumor activity [1,2]. With the primary interest being focused on the demonstration of the unique potential the Ni/Cr-mediated coupling reaction offers [3,4], we were engaged with the synthetic work on this class of natural products. A total synthesis of halichondrin B (**1**) was accomplished through an extensive use of this coupling reaction [5,6].

When the first total synthesis of halichondrin B was completed, we asked Dr. Bruce Littlefield at Eisai Research Institute (ERI) to test the in vitro and in vivo antitumor activities of the synthetic halichondrins as well as several synthetic intermediates. Littlefield's experiments demonstrated that the right half **2** of the halichondrins exhibits the in vitro biological profile virtually identical to that of halichondrin B itself. Disappointingly, **2** did not show the in vivo antitumor efficacy as halichondrin B did. Fortunately, however, the nor-gluco right half (i.e., the substrate bearing a HOCH₂, instead of HOCH₂CH₂, at C36 and α -OH, instead of β -OH, at C35 in **2**) exhibited extraordinarily potent antitumor activities in both in vitro and in vivo experiments that were comparable to those of halichondrin B [5m,7]. Based on this exciting discovery, ERI undertook the massive drug discovery efforts, through which two exceptional drug candidates **3** and **4** have emerged [7]. The National Cancer Institute (NCI) has recently begun a Phase I study on **3**.

We undertook the halichondrin project for pure academic interests. However, it has become clearer than ever to us that development of an economically feasible synthesis of the right half of hali-

*Lecture presented at the 14th International Conference on Organic Synthesis (ICOS-14), Christchurch, New Zealand, 14–18 July 2002. Other presentations are published in this issue, pp. 1–70.

[‡]Corresponding author

chondrin B and/or ERI's drug candidates is *the* key for success of this program. The structural complexity of the right half of halichondrin B, or of ERI's drug candidates, exceeds by far the structural complexity found in any synthetic drug on the market. We believe that contemporary synthetic organic chemistry has the capacity and potential to meet this type of challenge. In this presentation, we discuss our efforts toward achieving this goal.

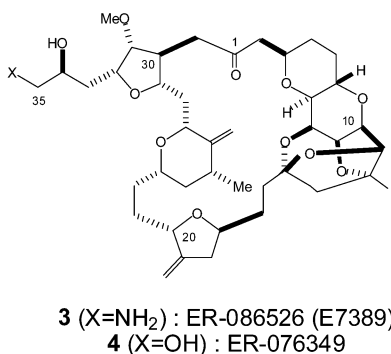
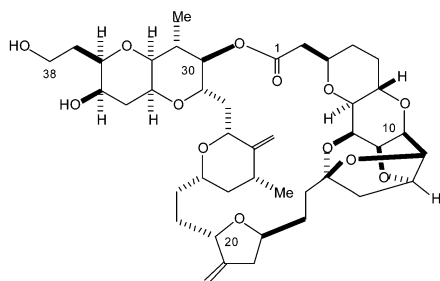
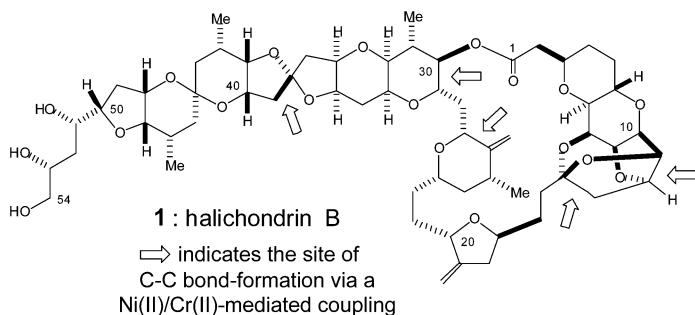

PRACTICAL SYNTHESIS OF THE C1–C13 SEGMENT OF HALICHONDRIANS

In our earlier report, we outlined a concise synthesis of the C1–C12 segment of halichondrins from L-mannoic γ -lactone [5g]. However, we wished to develop a new synthesis of this segment for two specific reasons. First, we recognized that the commercial availability of L-mannoic γ -lactone is not as steady as one wishes for. Second, one of the key transformations used in that synthesis was dihydroxylation of an enol ether, but we realized some difficulties associated with scaling this step, including: (1) the preparation of the enol ether is not well suited for a large-scale synthesis and (2) the stereoselectivity of dihydroxylation is excellent under stoichiometric conditions, but only modest under catalytic conditions.

On screening commercially available, possible chiral starting materials, we noticed that the C2, C3, and C4 stereochemistry of L-lyxose matches the C9, C10, and C11 stereochemistry of halichondrins, respectively. However, because of the cost of L-lyxose, we opted to invert the C4 stereochemistry of inexpensive D-ribonic γ -lactone, whose availability appears to be very steady. After protection of the C2 and C3 hydroxyl groups as a cyclohexylidene, the C4 stereochemistry of D-ribonic γ -lactone was inverted. This inversion is known in the literature but is carried out in a step-wise manner [8]. After extensive experimentation, a scalable, one-pot procedure was developed to effect the inversion in 86 % yield. Protection of the C6 hydroxyl group, followed by diisobutylaluminum hydride (DIBAL) reduction, furnished the properly protected L-lyxose **7** in excellent overall yield.

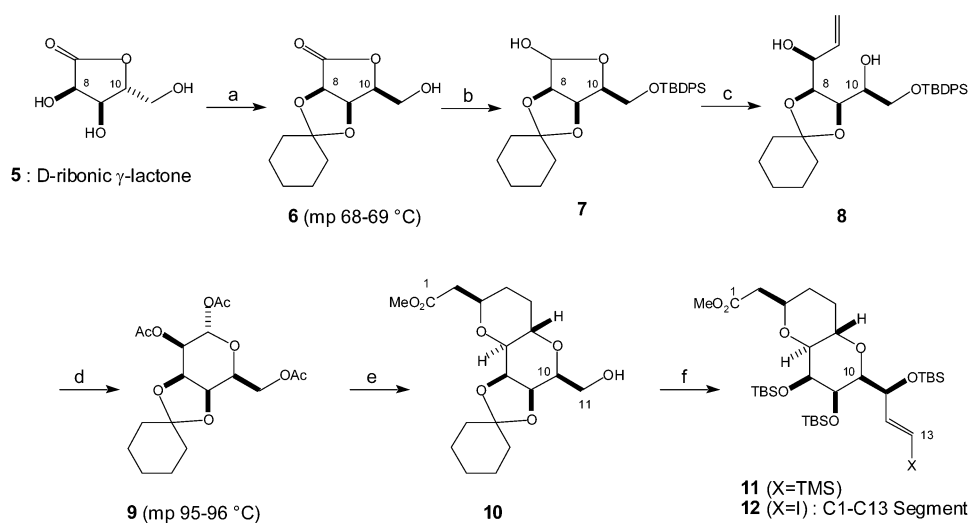

Scheme 1 Reagents and conditions. (a) 1. Cyclohexanone (2 equiv)/H₂SO₄/0 °C \rightarrow RT (85 %). 2. i. MsCl/py/THF. ii. aq. KOH. iii. aq. HCl (one-pot; 86 %). (b) 1. TBDPS-Cl/imid. 2. DIBAL (99 % overall). (c) [(*c*-Hex)₂N]₂Mg (1.5 equiv)/CH₂=CHMgBr (5 equiv)/THF/-78 °C \rightarrow 0 °C (95 %; 15:1 stereoselectivity). (d) 1. O₃/MeOH. 2. TBAF/THF. 3. Ac₂O/py. 4. Recrystallization (73 % overall from **6**). (e) 1. CH₂=CHCH(TMS)CH₂CO₂Me (1.6 equiv)/BF₃·OEt₂/TMSOTf/MeCN. 2. Triton B(OMe)/THF (86 % overall). (f) 1. Swern oxidation. 2. Ni/Cr-coupling/*trans*-TMSCH=CHI/DMSO (75 %; >15:1 stereoselectivity). 3. AcOH/TFA/H₂O. 4. TBSOTf/2,6-lutidine (73 % for 2 steps). 5. NIS/MeCN:ClCH₂CN (9:1) (80 %).

There are good precedents for organomagnesium and organolithium reagents reacting well with hemiacetals derived from ribose and mannose. However, the work by Singh and coworkers suggests that hemiacetals derived from lyxose such as **7** might not behave well toward organometallic reagents [9]. Experimentally, vinylmagnesium bromide was found to react with **7** in tetrahydrofuran (THF) to yield a 4:1 mixture of the expected products. However, we observed that: (1) this transformation required a large excess (20 equiv) of the nucleophile and (2) its reproducibility was poor; the chemical conversion varied from 0 to 90 %. To overcome this difficulty, two issues need to be addressed; one is a method to unmask the hemiacetal and generate the aldehyde, and the other is a stereoselective addition of the nucleophile to the resultant aldehyde. We assumed that the addition of a magnesium-based base not only facilitates the hemiacetal-unmasking process but also forms a cyclic magnesium-complex, which might provide a sharp facial differentiation for the nucleophilic addition. Considering the pK_a difference between hydroxyl and amino groups, we were particularly interested in an amido magnesium base. It was found that addition of *t*-BuOMgBr or (*i*-Pr)₂NMgBr greatly improved the reproducibility of the reaction, but the stereoselectivity declined. Upon addition of (*c*-hexyl)₂NMgBr, the stereoselectivity was significantly improved, but the reproducibility of reaction was not at a satisfactory level. The problems were ultimately solved by using a new bis(amido)magnesium base [(*c*-hexyl)₂N]₂Mg; in the presence of 1.5 equiv of this base, vinylmagnesium bromide (5 equiv) nicely added to **7** to furnish the desired product **8** with high conversion, stereoselectivity, and reproducibility [10,11]. Based on the literature precedent [9], the C9 stereochemistry of the major product was tentatively assigned as indicated in **8**, which was later confirmed through correlation of the C1–C11 segment produced from this synthesis with the sample from the previous syntheses [5b,g,i]. Ozonolysis of **8**, followed by one-pot desilylation and acetylation, gave the triacetate **9** in 73 % overall yield from **6**.

Following the chemistry previously established in this laboratory [5i,j], the triacetate **9** was efficiently converted to the C1–C13 segment **12**. Nevertheless, several comments are worthy of mention.

First, the triacetate **12** behaved exceptionally well toward $\text{CH}_2=\text{CHCH}[\text{Si}(\text{Me})_3]-\text{CH}_2\text{CO}_2\text{Me}$; only 1.6 equiv of the allylsilane were sufficient to complete the *C*-allylation in the presence of $\text{BF}_3 \cdot \text{Et}_2\text{O}$ (3 equiv) and trimethylsilyl triflate (TMSOTf) (0.25 equiv) in MeCN at 0 °C, with >50:1 stereoselectivity. As observed previously, the *C*-glycosidation product existed as a mixture (ca. 4:1 in CDCl_3) of the two conformers. Second, the crude *C*-allylation product was treated with Triton-B(OMe) in THF at 0 °C, which effected a series of transformations, including deacetylation, double-bond isomerization, oxy-Michael cyclization, and thermodynamically controlled C3 equilibration, to furnish **10** in 86 % overall yield for the two steps, with >50:1 stereoselectivity. Third, the Ni/Cr-mediated coupling allowed us to introduce the *E*-TMS-CH=CH- group with >15:1 stereoselectivity, cf., **11**. Fourth, the vinyl TMS group was then converted into the vinyl iodide in a mixture of $\text{ClCH}_2\text{CN}/\text{MeCN}$ without disturbing the C11 stereocenter.

PRACTICAL SYNTHESIS OF THE C27–C35 SEGMENT OF ER-076349 AND ER-086526

The halichondrin right half **2** and ER-086526 **3**/ER-076349 **4** have the same structure at the C1–C27 portion but differ at C28 and beyond. Having had an effective synthesis of the C27–C38 segment of **2** [5c], we focused on development of a practical synthesis of the C27–C35 segment of **3** and **4**.

D-(+)-Glucurono-6,3-lactone contains several appealing structural features as a possible starting material for a synthesis of the C27–C35 segment **18** of ER-086526 **3** and ER-076349 **4**. With small modifications of the literature-known procedures, D-glucurono-6,3-lactone was converted to 1,2-*O*-isopropylidene- α -D-5-deoxyglucurono-6,3-lactone (**13**) in excellent overall yields [12]. DIBAL reduction of **13**, followed by Wittig reaction and then *O*-benzylation [13], uneventfully provided the olefin **14**.

It was planned to introduce the C34/C35-diol via catalytic, asymmetric dihydroxylation [14]. Asymmetric dihydroxylation of terminal olefins such as the one present in **14** is known to suffer often from a low degree of asymmetric induction, but we hoped that a structural modification of the olefinic group in **14** would improve the selectivity. Asymmetric dihydroxylation of **14** was screened in the presence of various ligands known in the literature; among them, the Sharpless $(\text{DHQ})_2\text{PYR}$ gave the best ratio (3:1 at 0 °C) [15]. As anticipated, replacement of the terminal olefin for an *E*-TMS-CH=CH- resulted in the much improved asymmetric induction (stereoselectivity = 16:1) in the presence of $(\text{DHQ})_2\text{PYR}$. However, because of the low overall efficiency in the synthesis of this substrate, we did not pursue this synthetic route further.

Ultimately, a practical solution emerged from the following experiments. After dibenzoylation, the crude dihydroxylation product was subjected to *C*-allylation with allyl-TMS. This transformation deserves three specific comments. First, the current *C*-allylation is closely related to the example reported in the literature [16]. Under the specified conditions, the α - and β -selectivity of the *C*-allylation was estimated to be at least 65:1. Second, the α -*C*-allylated product **15** derived from the major, desired product formed in the dihydroxylation exhibited an excellent crystallinity, whereas the α -*C*-allylated product derived from the minor, undesired product formed in the dihydroxylation stayed as oil. This remarkable difference in chemical property immediately suggested the possibility of isolating **15** without separation at the dihydroxylation stage. Indeed, the crude product obtained in the dihydroxylation and *C*-allylation was directly subjected to crystallization to give the first crop of product, with at least 20:1 ratio at the C34 stereocenter, in 58 % overall yield from **14**. The mother liquor consisted primarily of a ca. 1:2 mixture of **15** and its C34 diastereomer, demonstrating the practicability of this procedure. Recrystallization of the first crop furnished **15** (>700:1 ratio) in 51 % overall yield from **14**.

Swern oxidation of **15**, followed by Horner–Emmons reaction with $\text{PhSO}_2\text{CH}_2\text{P}(\text{O})(\text{OEt})_2$ [17], furnished a 4:1 mixture of the geometric isomers of α,β -unsaturated sulfones. There are two potentially enolizable sites in the ketone and α,β -unsaturated sulfone, but there was no epimerized product detected in this transformation [13].

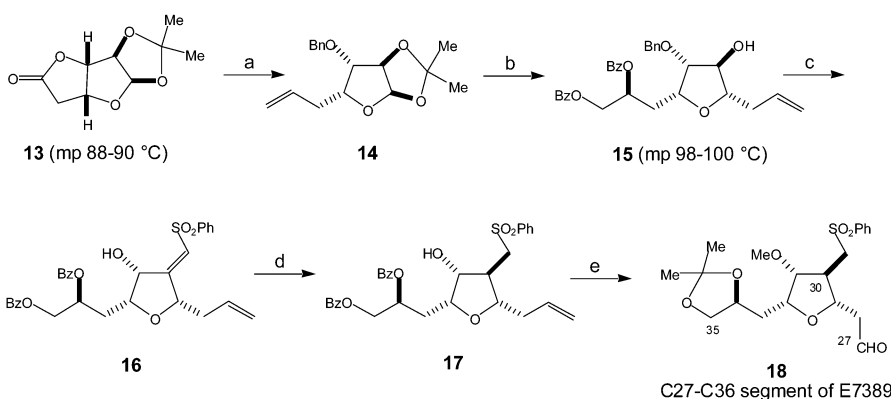

Scheme 2 Reagents and conditions. (a) 1. DIBAL/CH₂Cl₂. 2. Ph₃PCH₃Br/*n*-BuLi/THF (85 % for 2 steps). 3. BnBr/NaH/*n*-Bu₄Ni/DMF (90 %). (b) 1. (DHQ)₂PYR/0 °C. 2. BzCl/*n*-Bu₄NCl/NaOH-H₂O. 3. allyl-TMS/Ti(*i*-PrO)Cl₃/CH₂Cl₂ (>60:1 stereoselectivity). 4. crystallization: 1st crop (20:1, 58 % overall yield from **14**); recrystallization: 1st crop (>700:1, 51 % overall yield from **14**). (c) 1. Swern oxidation. 2. PhSO₂CH₂P(O)(OEt)₂/*n*-BuLi/THF (86 % for 2 steps). 3. FeCl₃/MS (AW-300)/benzene/RT (75 %). (d) NaBH(OAc)₃/THF/70 °C (70 %). (e) 1. MeI/Ag₂O/MS (4Å)/toluene/RT (90 %). 2. LiOH/aq. MeOH-THF/RT (93 %). 3. (MeO)₂C(Me)₂/*p*-TsOH/CH₂Cl₂/RT (93 %). 4. O₃/MeOH (80 %).

We planned to incorporate the C30 stereocenter via hydride reduction under the influence of a hydroxyl group(s) [18]. Although a hydroxyl group(s) at C27, C34, or C35 could serve as a directing group, none of them was found to be effective for achieving the desired reduction. Thus, it was necessary to rely on the C31 hydroxyl group and, for this reason, this hydroxyl group had temporarily been protected as a benzyl group. Screening Lewis acids, FeCl₃ was found to be effective in selectively deprotecting the benzyl group to form **16**. At the early phase of study, this transformation presented a problem in reproducibility and scale-up. After considerable experimentation, addition of molecular sieves (AW-300) was found to solve this problem. Interestingly, although the starting material was a ca. 4:1 mixture of *E*:*Z* isomers, the isolated product was the pure *E* isomer. Using stereochemically homogeneous samples, the *Z* isomer was shown not to survive under the deprotection condition.

Hydroxyl-directed reduction of **16** exclusively furnished **17**. The NaBH(OAc)₃-reduction did not proceed with the substrate bearing a MeO group at C31, whereas LiAlH₄- or LiBH₄-reduction of this substrate smoothly proceeded but yielded the C30 α -isomer. These results supported the view of hydroxyl-directed hydride reduction, thereby suggesting the newly introduced C31 stereochemistry to be the desired β -configuration. This assignment was further confirmed through nuclear Overhauser effect (NOE) experiments.

Methylation of the C31 hydroxyl group was attempted with methyl iodide in the presence of silver oxide at room temperature (RT). The reaction stopped at 50~70 % completion under these conditions, but it was found that, on addition of molecular sieves (4Å), the methylation smoothly proceeded to completion to furnish the methyl ether **18** in an excellent overall yield. For practical purposes, we routinely carried out the synthesis from **15** to **18** without purification of the intermediates, and the product was isolated by reprecipitation of the primary alcohol corresponding to **18** from methylene chloride/hexanes at -78 °C. In this manner, the C27-C35 segment **18** of ER-086526 **3**/ER-076349 **4** was obtained without chromatographic purification in 28 % overall yield from **15**.

SYNTHESIS OF THE C20–C26 SEGMENT VIA REGIOSPECIFIC AND STEREO-SELECTIVE S_N2' REACTION

In earlier work [5b], we demonstrated that the C26–C27 bond of the halichondrins can effectively be formed via Ni/Cr-mediated coupling, cf., **18** + **39** → **40** (Scheme 9). Obviously, for effective use of this transformation, an efficient synthesis of alkenyl halides (or triflates) such as **39** is required. For the synthesis of such an alkenyl halide, at least two issues should be addressed; one is a method to incorporate the alkenyl halide functionality itself and the other is a method to selectively incorporate the two stereocenters at C23 and C25. We recognized the possibility that the transformation of **I** → **II** might give a solution to both issues (Scheme 3). The preferred conformation of an allylic system is known to be eclipsed [19]. Among the three eclipsed conformers, **A** and **B** are expected to be preferred over **C** for the steric reason (Fig. 1). Assuming that this conformational preference is reflected in the transition state and also that the hydroxyl group directs the delivery of a “Me”-anion, one would expect that the proposed reaction preferentially proceeds through the transition state resembling **A**, to furnish the desired vinyl iodide in a stereo- and regioselective manner. Relevant to the proposed delivery of a “Me”-anion by a hydroxy group, Gallina [20] demonstrated that *N*-phenylcarbamate group is an effective directing group in a cuprate-mediated S_N2' reaction, whereas Nakamura [21] showed that the stereochemical outcomes of cuprate-mediated S_N2' reactions of δ -alkoxy allylic chlorides are explained by simple steric effects. To the best of our knowledge, there is no study reported in which a hydroxyl group serves as a directing group in an organocuprate-mediated addition in an acyclic system [22]. Also, there is no study reported on the stereochemical course of an organocuprate-mediated S_N2' reaction for an acyclic homoallylic alcohol or its derivatives [22]. It should also be noted that an impressive level of regio- and enantioselectivity has been realized in chiral auxiliary-based, asymmetric S_N2' reactions in recent years [23], and these reactions could be applied selectively to transform **I** (X = a leaving group bearing a chiral auxiliary) into **II**, but we opted to study the hydroxyl-directed S_N2' substitution because of the simplicity of the synthetic operations as well as the cost considerations.

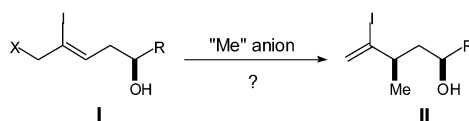

Scheme 3

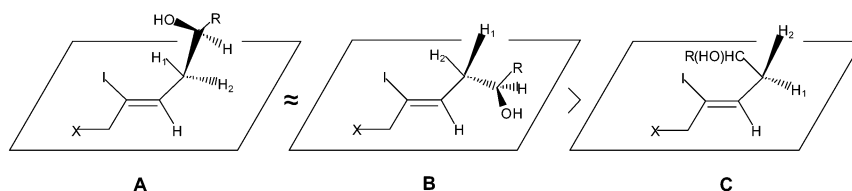
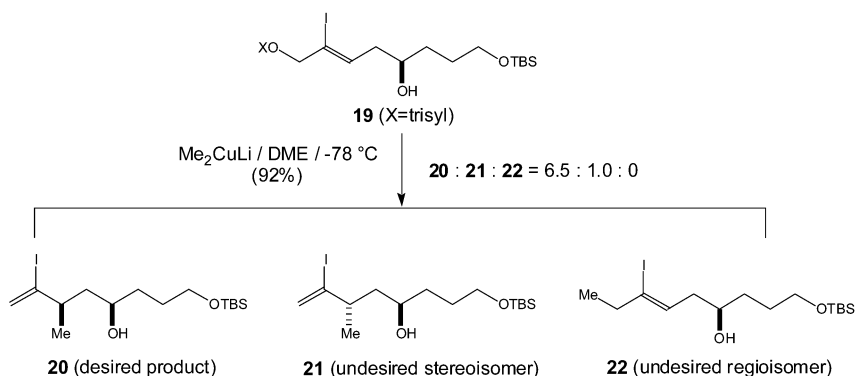

Fig. 1

Treatment of the mono-tosylate (i.e., X = Ts in **19** [24]) with lithium dimethyl cuprate in THF furnished a 2.7:1:1 mixture of the desired product **20**, the undesired C25 stereoisomer **21**, and the undesired regioisomer **22**. Encouraged with this result, we screened “Me”-anions, solvents, and leaving groups. Among cuprates tested, lithium dimethylcuprate gave the best result. The regio- and stereo-selectivity were dramatically affected by solvents; most notably, formation of the undesired regioisomer was completely eliminated in 1,2-dimethoxyethane (DME), with an increase in the stereoselectivity as well. The best results (**20**:**21**:**22** = 6.5:1:0) were obtained with a trisyl leaving group in DME.

Related to the proposed hydroxyl-directed S_N2' reaction, it is worthwhile adding two observations. First, with protection of the C23 hydroxyl group, the stereoselectivity observed in the S_N2' displacement is completely abolished. Second, it would be interesting to compare the directing capacity of the hydroxyl group with that of the *N*-phenylcarbamate for the S_N2' substitution. However, in spite of extensive efforts, we were unable to cleanly prepare the corresponding C23 *N*-phenylcarbamate.



Scheme 4

STOICHIOMETRIC, ASYMMETRIC Ni/Cr-MEDIATED COUPLING REACTIONS

As demonstrated in a number of examples, the Ni/Cr-mediated coupling reaction has shown its unique potential most, when applied to a polyfunctional molecule [3,4]. Thus, this reaction shows its power at a late stage in a multistep synthesis where scalability and practicability are not necessarily the top priority. However, in order to use the Ni/Cr-mediated coupling reaction for practical purposes, one must pay attention to two specific issues. First, since this coupling reaction is typically carried out in the presence of 3~4 equiv of CrCl_2 , it is highly desirable to develop a method to reduce the amount of Cr salt. Second, it is also desirable to develop an asymmetric process to control the stereochemical course. This analysis immediately calls for development of a catalytic, asymmetric Ni/Cr-mediated coupling reaction [25]. In this connection, we would like to quote the example previously studied in this laboratory: the C29/C30 bond of halichondrins was asymmetrically formed in the presence of chiral dipyrindyl ligand **26** [5h].

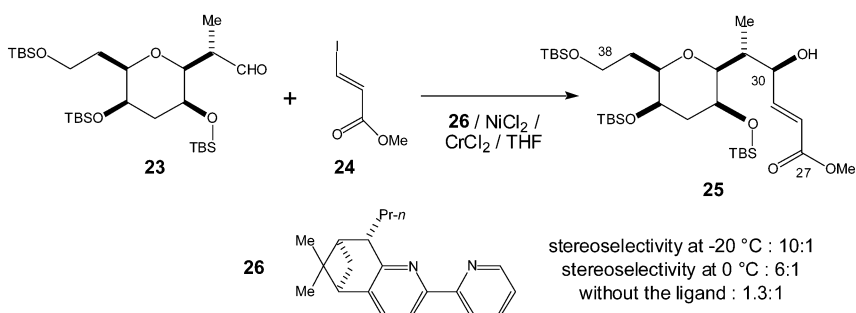

Scheme 5

Related to the current project, we were specifically interested in development of a catalytic, asymmetric Ni/Cr-mediated coupling that would allow us to achieve the overall transformation depicted in Scheme 6. Obviously, such a transformation can be applied to a synthesis of the C17–C20 and C23–C27 ring systems, and we chose to use the model substrates of **27** and **28** for this study. Disappointingly, the

chiral dipyrindyl ligand **26** was found not to induce an enantiometric excess for this system. Among numerous chiral ligands tested, the Kibayashi ligand **30** [25a] gave a modest but definitive asymmetric induction. With consideration of the pK_a similarity between phenolic and sulfonamido groups, the Fujisawa ligand **31** [26] was then tested, which gave a slightly improved asymmetric induction. We soon recognized that replacement of the *ortho*-hydrogen for a methyl group results in a major impact on the asymmetric induction, cf. **32**. Being encouraged by this preliminary observation, we then made extensive efforts on optimization of **32**, through which several promising ligands have emerged, including **34**, **35**, and **36** [27].

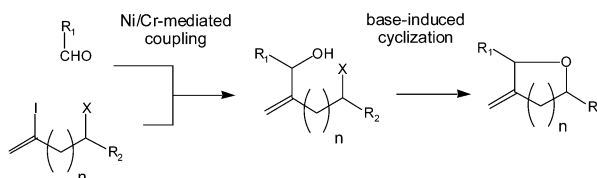

Scheme 6

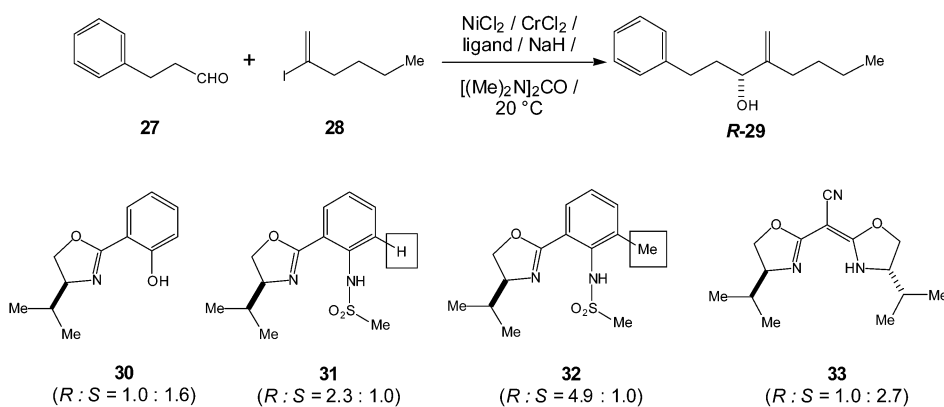

Scheme 7

Curiously, the major enantiomer formed in the presence of the sulfonamide ligand **32** was found to be opposite to that formed in the presence of the phenol ligand **30** as well as the C_2 -symmetric semicorrin ligand **33** [28,29]. These observations led us to a speculation that the coordination mode of a sulfonamide ligand is different from that of a phenol or semicorrin ligand. A single crystal of the Cr(III)-ligand complex **37** was obtained, and its X-ray analysis ultimately demonstrated that the sulfonamide **32** is a tridentate ligand [30]. In addition, the X-ray structure revealed several unique structural features, including: (1) **37** possesses an almost perfect octahedral structure, (2) the isopropyl group

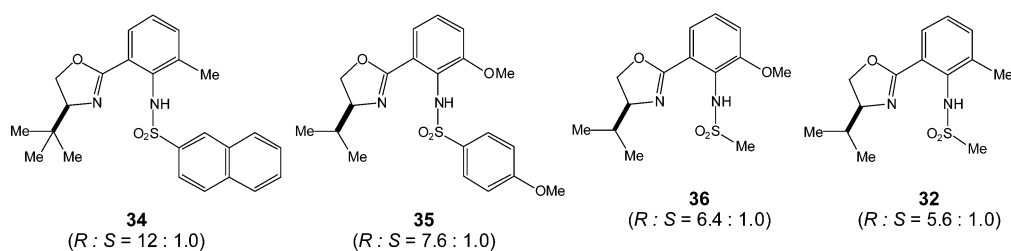

Scheme 8

is *cis* to the sulfonamide chain, (3) one of the sulfonamide oxygens is located above the phenyl ring, and (4) the sulfonamide nitrogen is *trans* to one of the chlorides. Naturally, we attempted to prepare a single crystal of an alkenyl-Cr(III)-ligand complex but without much success. However, a single crystal of methyl-Cr(III)-ligand complex **38** was obtained, whose structure is amazingly similar to that of the Cr(III)-ligand complex **37** (Fig. 2) [30].

These Cr(III)-ligand complexes do not necessarily correspond to the organometallic species actually involved in this chemical transformation. Nonetheless, it is tempting to use the X-ray structures to speculate about possible events (Fig. 3). At present, it is not established whether the bond-forming step

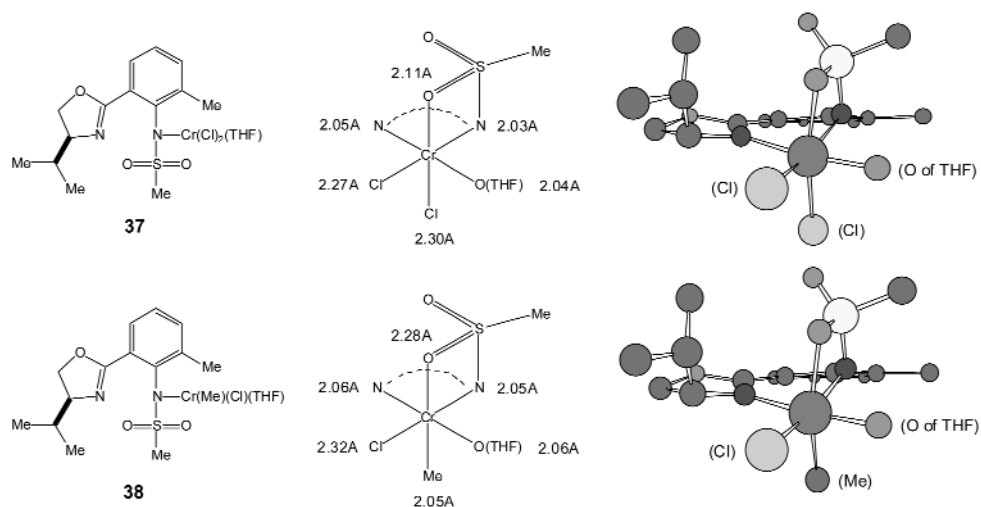

Fig. 2

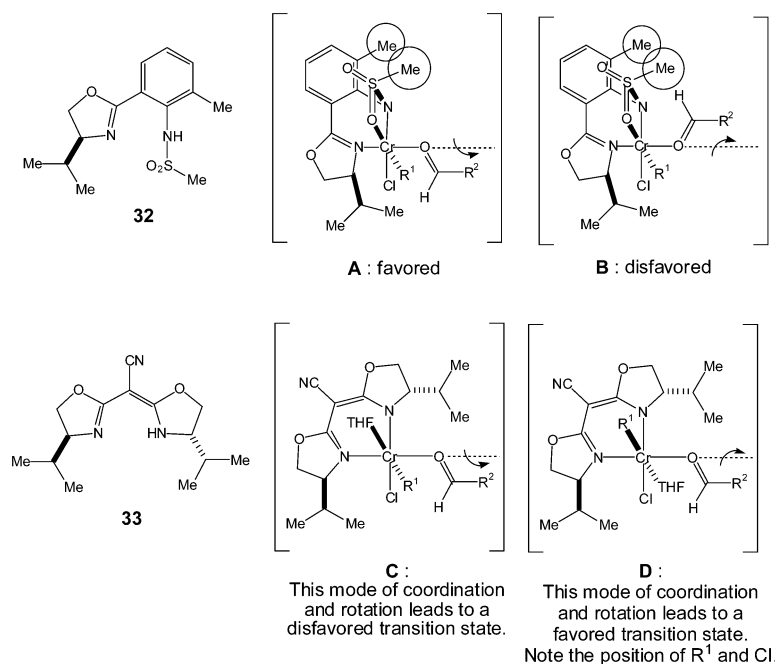

Fig. 3

involves a mono- or bimetallic species. However, we assume a four-centered process involving one vinylchromium species [31]. We further assume: (1) the alkyl-Cr(III)-ligand **38** represents the alkenyl-Cr(III)-ligand complex that participates in the bond-forming process, (2) an aldehyde takes over the THF-ligation site of **38**, and (3) the aldehyde coordinates to the metal center with an *s-trans* conformation [32–34] and, with progress of the reaction, the aldehyde rotates toward the alkenyl group, cf., an arrow. With these assumptions, only two coordination modes **A** and **B** between **27** and **37** need to be considered. Interestingly, the top-right quarter in the complex **37** is sterically more congested than the bottom-right quarter, and the **27/37** complex **A**, which leads to the observed major enantiomer, is considered to be favored over the **27/37** complex **B**.

We assume that the bond-forming events in the presence of the semicorrin ligand **33** are parallel to those in the presence of the sulfonamide ligand, including the alkenyl group occupying the axial ligation site. Because of the C_2 -symmetric nature, the alkenyl-Cr(III)-semicorrin complexes **C** and **D** are identical (Fig. 3). However, with progress of the reaction, the aldehyde needs to rotate toward the alkenyl group, resulting in desymmetrization of the two complexes; namely, this operation leads to the two transition states in which the *i*-propyl group in the ligand is either *trans* or *cis* to the R^2 group in the aldehyde moiety. For this steric reason, the latter transition state, which leads to the observed major enantiomer, is considered to be favored over the former.

The explanations given are consistent with the currently available experimental observations. However, with no direct experimental support, it should be considered as a working hypothesis. Nevertheless, it should serve us in designing and developing the next generation of chiral ligands for the Cr-mediated reactions.

Having had some success in development of asymmetric Ni/Cr-mediated coupling under the stoichiometric conditions, we then used the C14–C38 segment of halichondrins as well as the C14–C35 segment of ER-086526 **3** and ER-076349 **4** for demonstration of its usefulness. The example shown in Scheme 9 is a representative.

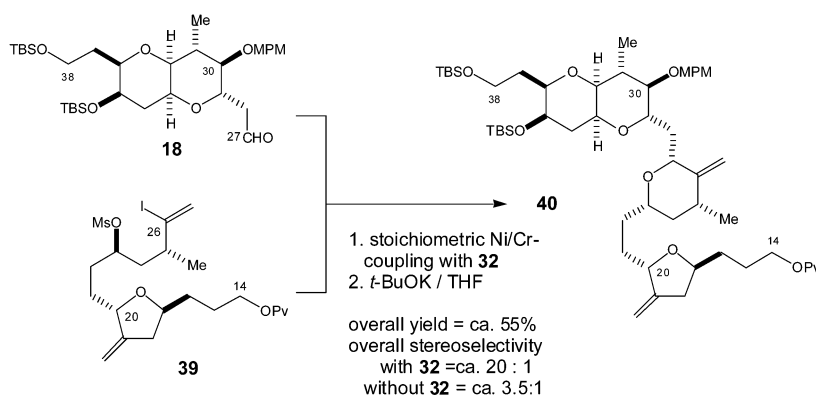

Scheme 9

CATALYTIC, ASYMMETRIC Cr(II)-MEDIATED REACTIONS

For a practical application, it is highly desirable to develop a catalytic process for the Ni/Cr-mediated reactions. In 1996, Fürstner and Shi reported seminal work on a catalytic process of the Ni/Cr-mediated coupling reaction, in which TMS-Cl and Mn(0) are used as a dissociating agent of chromium-alkoxides and a reducing agent of chromium, respectively [35]. Electrochemically driven Cr(II)-mediated couplings were also reported [36].

We were curious to know whether the crystalline Cr(III)/sulfonamide ligand complex **37** works as a catalyst for the Ni/Cr-mediated coupling. Under the Fürstner conditions in THF at RT, instead of

DME/dimethylformamide (DMF) at 50 °C, the Ni/Cr-mediated coupling of **27** with **28** was found to proceed smoothly in the presence of **37** (10 mol %) and NiCl₂ (10 mol %), to give the expected product in an excellent chemical yield with encouraging enantiomeric excess. With the same substrates in the presence of a catalyst **37** or **41**, optimization studies were conducted, revealing: (1) both **37** and **41** function are effective catalysts, (2) TMS-Cl is the best agent to dissociate chromium-alkoxides, (3) Mn(0) is the most effective reducing agent, (4) the addition of (Bn)(*n*-Bu)₃NCl or Et₃N·HCl enhances the coupling efficiency, (5) the addition of LiCl enhances the coupling rate, (6) EtCN and THF are good solvents [37], (7) 10 mol % of **37** and **41** is sufficient to complete the coupling within 24 h at RT, (8) the optimal temperature is around RT but the reaction proceeds at 0 °C, and (9) the optimal range of concentration is 0.5~0.1 M.

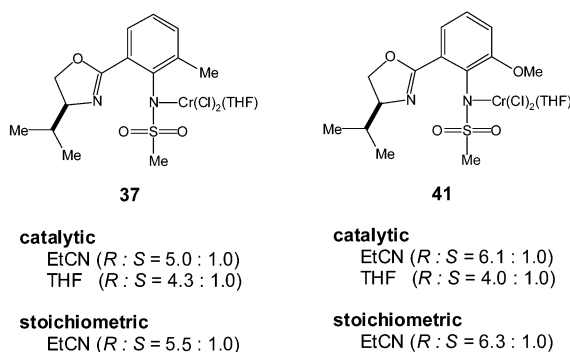

Scheme 10

The enantiomeric excess observed for the catalytic process in THF was found to be lower than that in the stoichiometric process. With the progress of coupling, a Lewis acid MnX₂ is formed that might have an effect of lowering the enantiomeric excess. However, the addition of MnCl₂ did not appreciably affect the enantiomeric excess. In addition, a rough time-course study indicated no noticeable change in the enantiomeric excess throughout the coupling reaction. Ultimately, the catalytic reaction in EtCN was found to proceed as efficiently as in THF and give the product in almost quantitative yield. Importantly, the enantiomeric excess obtained in the catalytic process in EtCN was found to be roughly comparable with that obtained in the stoichiometric process (Scheme 10) [37].

All these results indicate that the asymmetric reaction developed in the stoichiometric process is translated well into the catalytic, asymmetric process, and we speculate that the critical bond-forming steps involved in the catalytic process are the same as those proposed for the stoichiometric process (Panel A in Fig. 4). Taking into account the relative rate of ligand exchange on Cr(II)- vs. Cr(III)-species [4], we assume that the transmetalation takes place at the Cr(II)-oxidation state, which is formed through chemical reduction of **37** by Mn(0). The structural information on the proposed Cr(II)/sulfonamide ligand complex is not available at this time, but an X-ray structure was obtained on Cr(II)(4-*tert*-butylpyridine)₃(Cl)₂ (**42**) (Fig. 5). This Cr(II) complex **42** possesses an unusual square-pyramidal geometry [38]. Interestingly, this structure can be viewed as an octahedral structure with one vacant ligation site. It is tempting to suggest that the proposed Cr(II)/sulfonamide ligand complex adopts a similar structure and that the vacant ligation site is involved in the transmetalation with the alkenyl-Ni(II) complex. The Cr(III)/ligand complex thus formed then proceeds through the steps suggested for the stoichiometric series, to furnish Cr(III)/ligand alkoxide. As suggested by Fürstner [35], TMS-Cl dissociates the Cr-alkoxide to give the TMS ether of **29** and regenerate the ligand-Cr(III) complex **37**. All the chemistry takes place only at the two ligation sites of **37**.

In addition, this process contains a catalytic cycle centered on the Ni salt, which is coupled with the Cr catalytic cycle and hence with the Mn-redox cycle (Panel B in Fig. 4). Lastly, the effect of LiCl

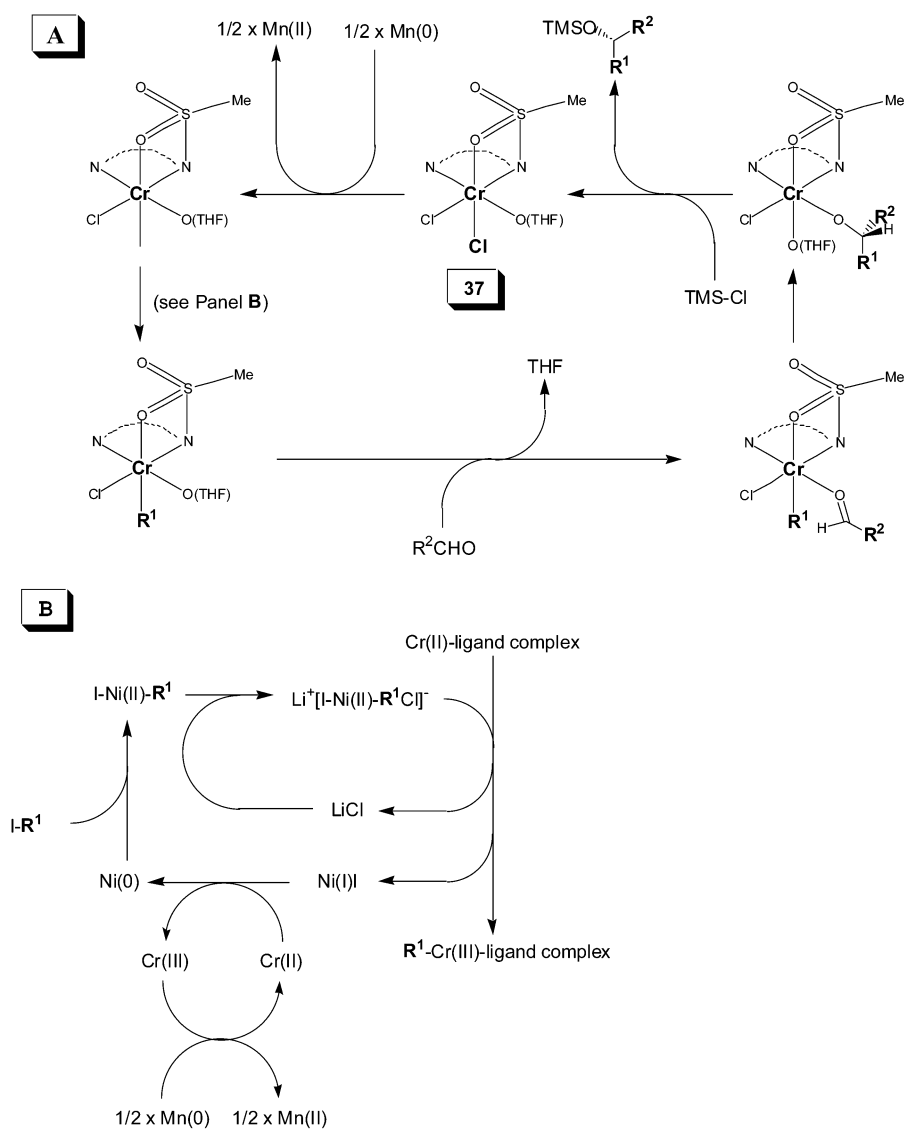

Fig. 4

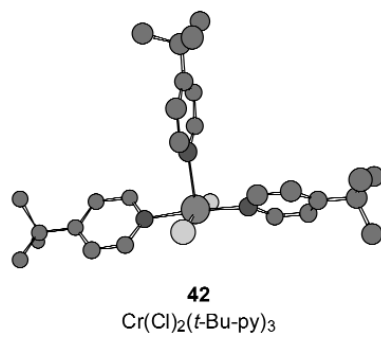
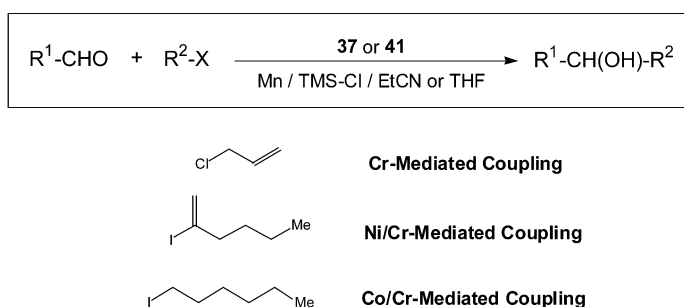

Fig. 5

on the overall reaction rate may be attributed to formation of the Ni-ate complex from the alkenyl-Ni(II) complex, enhancing the rate of transmetalation.

Overall, the catalytic Ni/Cr-mediated coupling reaction relies on the two catalytic cycles. Therefore, in order to achieve this bond-forming process economically in the terms of the Cr(III)/sulfonamide ligand complex **37**, it is important to realize an efficient catalytic cycle not only for Cr salt but also for Ni salt. It appeared that the efficiency for the Cr catalytic cycle is sufficiently good but that of the Ni catalytic cycle, especially in EtCN, needs an improvement. In practice, the catalytic reaction in the presence of 10 mol % of **37** with either 20–40 mol % of NiCl₂ or 4–6 mol % Ni(COD)₂ gave a significantly improved reproducibility [39]. Considering the fact that the stoichiometric coupling is routinely performed in the presence of 3–4 equiv of CrCl₂, the current catalytic process represents a reduction of Cr use by a factor of 30–40.

We would like to point out the possibility that the Cr(III)/sulfonamide complexes **37** and **41** can be potentially applied to any chemistry associated with a Cr species, and we are currently studying the scope that these complexes may offer. Somewhat related to this issue, it should be noted that the Cr-mediated coupling reactions are grouped into three subgroups (Scheme 11); allyl halides are activated by Cr(II)-species alone [40], whereas alkenyl halides and alkyl halides are activated through Ni(0)- and Co(I)-species, respectively [3,41]. Gratifyingly, the ligand-Cr(III) complex shows good applicability for all the three subgroups of Cr-mediated coupling reactions, which certainly expands the scope of Cr-mediated reactions.



Scheme 11

The synthesis of the C14–C26 segment of halichondrins illustrates this point further (Scheme 12). The first bond formation was achieved via a catalytic, asymmetric Ni/Cr-mediated coupling reaction; in the presence of 10 mol % of the antipode of **37** with either 40 mol % of NiCl₂ or 5 mol % of Ni(COD)₂, the coupling of **43** with **44** furnished the desired product. Treatment of the crude coupled product with PPTS/Py/*i*-PrOH not only removed the resultant C20 TMS-silyl ether but also effected the cyclization [42]. After debenzoylation, the stereochemically homogeneous **45** was isolated by silica gel chromatography in 70–80 % overall yield from **44** with ca. 9:1 overall stereoselectivity.

A catalytic, asymmetric Co/Cr-mediated coupling reaction was used for the C23–C24 bond formation. Takai and Uchimoto showed that alkyl halides and tosylates are coupled with aldehydes in the presence of CrCl₂ and a catalytic amount of vitamin B₁₂ or cobalt phthalocyanine [41]. Using a model system, we have first established that **37** acts as a catalyst for the Co/Cr-mediated coupling reaction and then applied this process to the diiodide **46**, to furnish the desired product **47** in 73 % yield, with a 5.3:1 stereoselectivity. The structure of **47** was established on comparison with the sample available from the previous synthesis [5b].

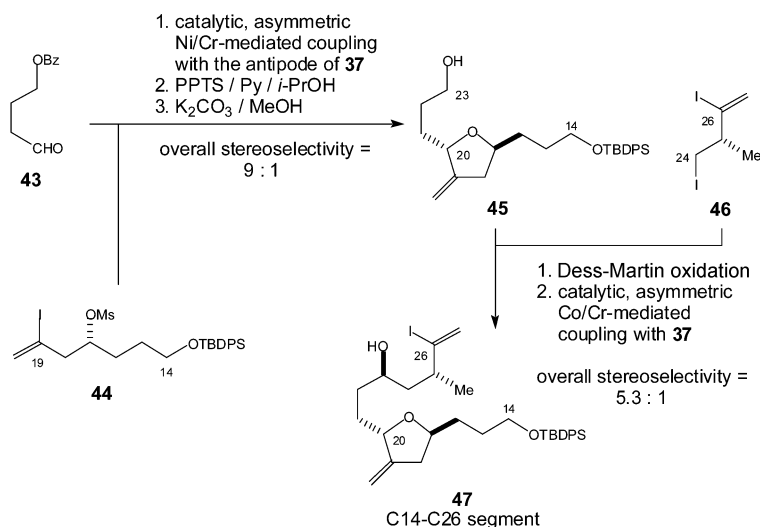

Scheme 12

CONCLUDING REMARKS

The halichondrin project was initiated with pure academic interests in the Ni/Cr-mediated coupling reaction, with the primary interest being focused on demonstration of the unique potential the Ni/Cr-mediated coupling reaction offers. Intriguingly, in connection with the development of a practical synthesis of the right half, or its analogs, of the halichondrins, the program has recently returned to the Cr-mediated coupling reactions again. Through the efforts outlined in this presentation, we have gained an increasingly optimistic view on meeting the challenge mentioned in the introduction.

ACKNOWLEDGMENTS

We are grateful to the National Institutes of Health (CA 22215) and ERI for generous financial support. D.D. thanks the National Institutes of Health for a postdoctoral fellowship (1 F32 AI50373-01).

REFERENCES AND NOTES

- (a) D. Uemura, K. Takahashi, T. Yamamoto, C. Katayama, J. Tanaka, Y. Okumura, Y. Hirata. *J. Am. Chem. Soc.* **107**, 4796 (1985); (b) Y. Hirata and D. Uemura. *Pure Appl. Chem.* **58**, 701 (1986).
- For isolation of the halichondrins from different species of sponges, see: (a) G. R. Pettit, C. L. Herald, M. R. Boyd, J. E. Leet, C. Dufresne, D. L. Doubek, J. M. Schmidt, R. L. Cerny, J. N. A. Hooper, K. C. Rutzler. *J. Med. Chem.* **34**, 3339 (1991); G. R. Pettit, R. Tan, F. Gao, M. D. Williams, D. L. Doubek, M. R. Boyd, J. M. Schmidt, J. C. Chapuis, E. Hamel, R. Bai, J. N. A. Hooper, L. P. Tackett. *J. Org. Chem.* **58**, 2538 (1993); (b) M. Litaudon, J. B. Hart, J. W. Blunt, R. J. Lake, M. H. G. Munro. *Tetrahedron Lett.* **35**, 9435 (1994); M. Litaudon, S. J. H. Hickford, R. E. Lill, R. J. Lake, J. W. Blunt, M. H. G. Munro. *J. Org. Chem.* **62**, 1868 (1997).
- (a) H. Jin, J. Uenishi, W. J. Christ, Y. Kishi. *J. Am. Chem. Soc.* **108**, 5644 (1986); (b) K. Takai, M. Tagashira, T. Kuroda, K. Oshima, K. Utimoto, H. Nozaki. *J. Am. Chem. Soc.* **108**, 6048 (1986).

4. For recent reviews on Cr-mediated reactions, see: (a) A. Fürstner. *Chem. Rev.* **99**, 991 (1999); (b) L. A. Wessjohann and G. Scheid. *Synthesis* **1** (1999); (c) N. A. Saccomano. *Comprehensive Organic Synthesis*, B. M. Trost and I. Fleming (Eds.), Vol. 1, p. 173, Pergamon, Oxford (1991).
5. (a) T. D. Aicher and Y. Kishi. *Tetrahedron Lett.* **28**, 3463 (1987); (b) T. D. Aicher, K. R. Buszek, F. G. Fang, C. J. Forsyth, S. H. Jung, Y. Kishi, M. C. Matelich, P. M. Scola, D. M. Spero, S. K. Yoon. *J. Am. Chem. Soc.* **114**, 3162 (1992); (c) T. D. Aicher, K. R. Buszek, F. G. Fang, C. J. Forsyth, S. H. Jung, Y. Kishi, P. M. Scola. *Tetrahedron Lett.* **33**, 1549 (1992); (d) K. R. Buszek, F. G. Fang, C. J. Forsyth, S. H. Jung, Y. Kishi, P. M. Scola, S. K. Yoon. *Tetrahedron Lett.* **33**, 1553 (1992); (e) F. G. Fang, Y. Kishi, M. C. Matelich, P. M. Scola. *Tetrahedron Lett.* **33**, 1557 (1992); (f) Y. Kishi. *Pure Appl. Chem.* **64**, 343 (1992); (g) J. J.-W. Duan and Y. Kishi. *Tetrahedron Lett.* **34**, 7541 (1993); (h) C. Chen, K. Tagami, Y. Kishi. *J. Org. Chem.* **60**, 5386 (1995); (i) D. P. Stamos and Y. Kishi. *Tetrahedron Lett.* **37**, 8643 (1996); (j) D. P. Stamos, A. G. Taylor, Y. Kishi. *Tetrahedron Lett.* **37**, 8647 (1996); (k) D. P. Stamos, X. C. Sheng, S. S. Chen, Y. Kishi. *Tetrahedron Lett.* **38**, 6355 (1997); (l) D. P. Stamos, S. S. Chen, Y. Kishi. *J. Org. Chem.* **62**, 7552 (1997); (m) Y. Kishi, F. G. Fang, C. J. Forsyth, P. M. Scola, S. K. Yoon. U.S. Patent 5338866, International Patent WO93/17650.
6. For synthetic work by Salomon, Burke, and Yonemitsu, see: (a) S. Kim and R. G. Salomon. *Tetrahedron Lett.* **30**, 6279 (1989); A. J. Cooper, W. Pan, R. G. Salomon. *Tetrahedron Lett.* **34**, 8193 (1993) and the references cited therein; (b) S. D. Burke, K. C. Lee, D. Santafianos. *Tetrahedron Lett.* **32**, 3957 (1991); B. C. Austad, A. C. Hart, S. D. Burke. *Tetrahedron* **58**, 2011 (2002) and the references cited therein; (c) K. Horita, S. Hachiya, M. Nagasawa, M. Hikota, O. Yonemitsu. *Synlett* **38** (1994); K. Horita, M. Nagasawa, Y. Sakurai, O. Yonemitsu. *Chem. Pharm. Bull.* **46**, 1199 (1998) and references cited therein.
7. (a) M. J. Towle, K. A. Salvato, J. Budrow, B. F. Wels, G. Kuznetsov, K. K. Aalfs, S. Welch, W. Zheng, B. M. Seletsky, M. H. Palme, G. J. Habgood, L. A. Singer, L. V. DiPietro, Y. Wang, J. J. Chen, D. A. Quincy, A. Davis, K. Yoshimatsu, Y. Kishi, M. J. Yu, B. A. Littlefield. *Cancer Res.* **61**, 1013 (2001); (b) Y. Wang, G. J. Habgood, W. J. Christ, Y. Kishi, B. A. Littlefield, M. J. Yu. *Bioorg. Med. Chem. Lett.* **10**, 1029 (2000); (c) B. A. Littlefield, M. H. Palme, B. M. Seletsky, M. J. Towle, M. J. Yu, W. Zheng. U.S. Patent 6214865, 6365759, and S/N 09/843,617, International Patent WO 99/65894 (pending).
8. For an example, see: H. Kold, I. Lundt, C. Pedersen. *Acta Chem. Scand.* **48**, 675 (1994).
9. B. Mekki, G. Singh, R. H. Wightman. *Tetrahedron Lett.* **32**, 5143 (1991).
10. Following the method reported for preparation of [(TMS)₂N]₂Mg: J. F. Allan, K. W. Henderson, A. R. Kenedy. *Chem. Commun.* 1325 (1999), [(c-hexyl)₂N]₂Mg was prepared from (c-hexyl)₂NH (2 equiv) and (n-Bu)₂Mg.
11. **7** showed no detectable aldehyde signal in the ¹H NMR spectrum in THF-d₈ containing 1.5 equiv of [(c-hexyl)₂N]₂Mg.
12. D-Glucurono-6,3-lactone was converted to **13** in 3 steps, i.e., (1) acetone/H₂SO₄ (99 %), (2) SO₂Cl₂/py (98 %), (3) Zn/aq. AcOH (74 %) or (n-Bu)₃SnH/(Et)₃B/O₂ (96 %).
13. An additional benefit was later recognized for this protection; enolization was detected in the series with a MeO group at C31 but not in the series with a BnO group.
14. For a review on this subject, see: H. C. Kolb, M. S. VanNieuwenhze, K. B. Sharpless. *Chem. Rev.* **94**, 2483 (1994).
15. (a) E. N. Jacobsen, I. Marko, W. S. Mungall, G. Schroder, K. B. Sharpless. *J. Am. Chem. Soc.* **110**, 1968 (1988); (b) K. B. Sharpless, W. Amberg, Y. L. Bennani, G. A. Crispino, J. Hartung, K.-S. Jeong, H.-L. Kwong, K. Morikawa, Z.-M. Wang, D. Xu, X.-L. Zhang. *J. Org. Chem.* **57**, 2768 (1992); (c) G. A. Crispino, K.-S. Jeong, H. C. Kolb, Z.-M. Wang, D. Xu, K. B. Sharpless. *J. Org. Chem.* **58**, 3785 (1992); (d) H. Becker and K. B. Sharpless. *Angew. Chem. Int. Ed.* **35**, 448 (1996).
16. F. Garcia-Tellado, P. Armas, J. J. Marrero-Tellado. *Angew. Chem. Int. Ed.* **39**, 2727 (2000).
17. T. A. Blumenkopf. *Synth. Commun.* **16**, 139 (1986).

18. For a review on substrate-directable chemical reactions, see: A. H. Hoveyda, D. A. Evans, G. C. Fu. *Chem. Rev.* **93**, 1307 (1993).
19. (a) R. W. Kilb, C. C. Lin, E. B. Wilson, Jr. *J. Chem. Phys.* **26**, 1695 (1957); (b) D. R. Herschbach and L. C. Krisher. *J. Chem. Phys.* **28**, 728 (1958).
20. (a) C. Gallina and P. G. Ciattini. *J. Am. Chem. Soc.* **101**, 1035 (1979); (b) C. Gallina. *Tetrahedron Lett.* **23**, 3093 (1982).
21. M. Arai, T. Kawasuji, E. Nakamura. *J. Org. Chem.* **58**, 5121 (1993).
22. In cyclic systems, allylic and homoallylic alcohols are known to direct the stereochemical course in conjugate additions of Grignard and cuprate reagents. For example, see: F. F. Fleming, J. Guo, Q. Wang, D. Weaver, *J. Org. Chem.* **64**, 8568 (1999) and references cited therein.
23. For examples of chiral-auxiliary based, asymmetric S_N2' reactions, see: (a) H.-J. Gais, H. Müller, J. Bund, M. Scommoda, J. Brandt, G. Raabe. *J. Am. Chem. Soc.* **117**, 2453 (1995) and the references cited therein.
24. **19** was prepared from $CH_2=CH(CH_2)_3OTBS$ in 5 steps: (1) MCPBA epoxidation; (2) Jacobsen kinetic resolution; (3) epoxide ring-opening with $TESOCH_2C\equiv CH$; (4) hydrostannylation, followed by iodination; and (5) trisylation.
25. For asymmetric Cr-mediated allylation, see: (a) K. Sugimoto, S. Aoyagi, C. Kibayashi. *J. Org. Chem.* **62**, 2322 (1997); (b) M. Bandini, P. G. Cozzi, P. Melchiorre, A. Umani-Ronchi. *Angew. Chem. Int. Ed.* **38**, 3357 (1999) and M. Bandini, P. G. Cozzi, A. Umani-Ronchi. *Tetrahedron* **57**, 835 (2001).
26. T. Fujisawa, T. Ichiyanagi, M. Shimizu. *Tetrahedron Lett.* **36**, 5031 (1995).
27. Three conditions, (1) Et_3N/THF , (2) $NaH/(Bn)(n-Bu)_3NCl/THF$, and (3) $NaH/1,3$ -dimethyl-3,4,5,6-tetrahydro-2(1H)-pyrimidinone (DMPU) or 1,1,3,3-tetramethylurea (TMU), were routinely used to screen a ligand. The ratios given in Scheme 8 were obtained under condition 1, whereas those given in Scheme 7 were obtained under condition 3.
28. (a) R. E. Lowenthal, A. Abiko, S. Masamune. *Tetrahedron Lett.* **31**, 6005 (1990); (b) E. J. Corey and Z. Wang. *Tetrahedron Lett.* **34**, 4001 (1993).
29. For a recent review, see: P. Braunstein and F. Naud. *Angew. Chem. Int. Ed.* **40**, 680 (2001).
30. The X-ray crystals were obtained as follows: (1) **32**/ $NaH/THF/RT/1$ h, (2) $CrCl_3-(THF)_3/RT/24$ h (THF), (3) pentane-dilution for **37** or (3) $(Me)_3Al/toluene/-5^\circ/1$ h, RT/14 h, and then $-20^\circ C/1$ D for **38**.
31. A four-centered transition state involving one vinylchromium species was suggested for an intramolecular Ni(II)/Cr(II)-mediated coupling: D. W. C. MacMillan, L. E. Overman, L. D. Pennington. *J. Am. Chem. Soc.* **123**, 9033 (2001) and **117**, 10391 (1995).
32. For the structure of benzaldehyde/boron trifluoride adduct, see: M. T. Reetz, M. Hullmann, W. Massa, S. Berger, P. Rademacher, P. Heymanns. *J. Am. Chem. Soc.* **108**, 2405 (1986).
33. For the rotational barriers, see: T. J. LePage and K. B. Wiberg. *J. Am. Chem. Soc.* **110**, 6642 (1986).
34. For a review, see: S. Shambayati, W. E. Crowe, S. L. Schreiber. *Angew. Chem. Int. Ed.* **29**, 256 (1990).
35. (a) A. Fürstner and N. Shi. *J. Am. Chem. Soc.* **118**, 2533 (1996); (b) A. Fürstner and N. Shi. *J. Am. Chem. Soc.* **118**, 12349 (1996).
36. (a) M. Kuroboshi, M. Tanaka, S. Kishimoto, G. Kentaro, H. Tanaka, S. Torii. *Tetrahedron Lett.* **40**, 2785 (1999); (b) R. Grigg, B. Putnikovic, C. J. Urch. *Tetrahedron Lett.* **38**, 6307 (1997); (c) M. Durandetti, J.-Y. Nedelec, J. Perichon. *Org. Lett.* **3**, 2073 (2001).
37. The rate of coupling was found significantly faster in MeCN than in EtCN. However, the enantioselectivity was significantly lower in MeCN than in EtCN.
38. $(\eta^1-C_4H_4N)_2Cr(Py)_3$ is known to possess an unusual square-pyramidal geometry similar to **42**: J. J. H. Edema, S. Gambarotta, A. Meetsma, F. van Bolhuis, A. L. Spek, W. J. J. Smeets. *Inorg. Chem.* **29**, 2147 (1990).

39. With addition of Ni(COD)₂ in several portions (3~4 × 1 mol %), the homocoupling of **28** could be avoided.
40. (a) Y. Okude, S. Hirano, T. Hiyama, H. Nozaki. *J. Am. Chem. Soc.* **99**, 3179 (1977); (b) Y. Okude, T. Hiyama, H. Nozaki. *Tetrahedron Lett.* **43**, 3829 (1977); M. Kuroboshi, M. Tanaka, S. Kishimoto, H. Tanaka, S. Torii. *Synlett.* 69 (1999).
41. K. Takai, K. Nitta, O. Fujimura, K. Utimoto. *J. Org. Chem.* **54**, 4732 (1989).
42. C20-TMS deprotection and subsequent cyclization were effected under various conditions, including (1) aq. oxalic acid, followed by silica gel treatment/EtOH or hexanes/CHCl₃, (2) montmorillonite clay/*i*-PrOH, (3) PPTS/*i*-PrOH, and (4) amberlite 15/*i*-PrOH.